



EtherHaul™ 614TX Product Description

August 2018

Release: 1.0

Table of Contents

1. Introduction	3
2. EtherHaul™ 614TX System Overview	6
2.1 Functional Blocks	6
2.2 EH-614TX General Specifications	7
3. EtherHaul™ 614TX product specifications	9
3.1 Frequency band, channels and modulation schemes	9
3.1.1 Frequency band	9
3.1.2 Channel sizes	9
3.1.3 Modulation	9
3.1.4 Standard compliance	9
3.1.5 Benefits	10
3.2 Radio Specifications	10
3.2.1 Transmit power, receiver sensitivity, channel capacity	10
3.2.2 Transmit power control	11
3.3 Antenna	11
3.3.1 Standard compliance	12
3.3.2 Benefits	12
3.4 Ethernet interfaces	12
3.4.1 Standard compliance	13
3.4.2 Benefits	13
3.5 System capacity	14
3.5.1 Benefits	14
3.6 Adaptive modulation	14
3.6.1 Benefits	15
3.7 Asymmetrical uplink/downlink ratio configuration	15
3.7.1 Benefits	15
3.8 Alignment	16
3.8.1 Benefits	16
3.9 Power	16
3.9.1 Input Power	16
3.9.2 Poe-Out	17
4. Networking capabilities and features	17
5. Management concept	18
6. Security	18
7. Logging and auditing features	18
8. Diagnostic tools	18
9. EtherHaul™ Deployment Topologies	18
10. List of supported standards by EtherHaul	19
11. References	20

Document Information

Revision	Date	Author	Revision notes
1.0	12 August 2018	SH	First release

Intended Audience

- Solution architects and network planning staff
- Telecom backhaul engineers
- Wireless ISP, business connectivity and wireless networks pre-sale engineers

Terminology used in this document assumes audience familiarity with millimeter wave radio communication and networking technologies.

Comments and suggestions are welcome to: info@siklu.com.

1. Introduction

This Product Description documents details the special features of the EH-614TX product, in reference to EtherHaul™ family generic characteristics which are reviewed in a companion document, the EtherHaul™ System Description (reference [1]), also available on Siklu's partners' portal. Radio performance, Mechanical and Power information, for example, are listed in this document, while the generic behavior of the family are explained in the companion document (example: L2 switching features). The 2 documents can be reviewed in the order suitable to the reader.

The EtherHaul-614TX (EH-614TX) radio delivers carrier-grade wireless point-to-point Gigabit Ethernet services utilizing the 57-71 GHz unlicensed V-band spectrum. The solution is designed and optimized for street level connectivity including small cell backhaul, security and CCTV wireless networks, Wi-Fi backhaul and other applications. The EH-614TX on one-hand meets the stringent requirements of service providers while on the other hand allows easy installation by non-Telco professional staff.

The EH-614TX is based on Siklu's revolutionary integrated-silicon technology, which results in a highly reliable, zero footprint, and low-cost radio.

The EH-614TX offers Gigabit throughput, MEF-compliant networking, 8 levels of QoS, enhanced hitless adaptive bandwidth, coding & modulation for maximum spectral efficiency, and services availability. It supports network synchronization, advanced OAM&PM tools and ring protection optimized for both small cell and mobile backhaul applications. It features multiple GbE interfaces, supporting complex network topologies, such as daisy chain, ring, and mesh. The multiple ports enable also colocation installation and leveraging the infrastructure for additional fixed services delivery. All in a very small and light outdoor package that is optimized for street level installations and designed to overcome pole sway, twist and/or tilt. The EH-614TX is fast, simple and inexpensive to deploy.

EH-614TX is well suited for street-level connectivity and includes the following features:

- Operation across 14GHz of V-band license-exempt spectrum, including the reduced oxygen affected upper-band in a single radio
- Field proven technology
- Reduced TCO and fast ROI
- All-outdoor invisible footprint
 - Small and light

- Quick and easy to install
- Optimized for street level deployments
 - Works on poles, buildings facades (walls), traffic lights and more
 - Designed to overcome sway, twist and/or tilt
- Spectral efficient
 - Widest range of frequencies
 - TDD modulation with seamless delay and jitter
 - Hitless adaptive bandwidth coding and modulation for high availability
- Advanced layer-2 features:
 - MEF-compliant services and QoS
 - VLAN & Provider Bridge with 9K jumbo frames support
 - Clear separation between multiple services with QoS
 - Enables QoS aware MPLS services delivery
 - SLA assurance
- Advanced AES encryption for secured street level deployments

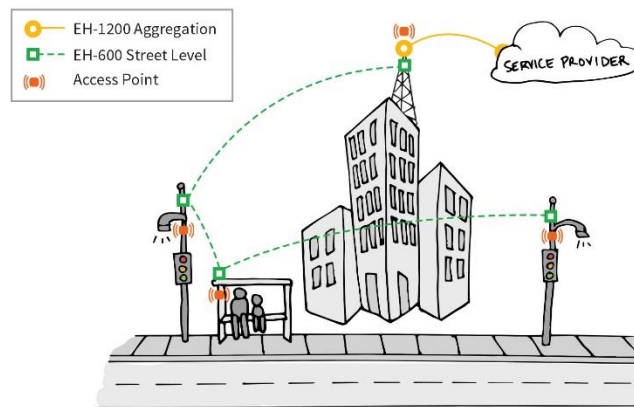

Figure 1 - Street level backhaul on various types of street furniture

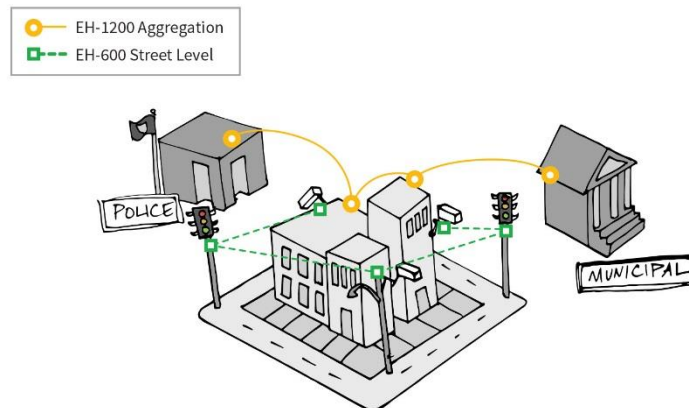

Figure 2 - street level security camera connectivity

Easily integrated into service-provider networks, out-of-the-box up & running capable. Highly-scalable, the EtherHaul™ products are software-upgradable to support future networking and routing capabilities as networks evolve.

The EtherHaul™ products features advanced adaptive modulation, bandwidth and coding - allowing operators to maintain, prioritize, and verify QoS in all weather conditions, while achieving maximum (up to 99.999%) link availability for prioritized services such as voice signaling.

Offering easy and low cost all-outdoor installation and a small form factor, the EtherHaul™ products are also environmentally-friendly - boasting a small system and antenna footprint with especially low power consumption.

The EtherHaul™ systems are High-capacity Gigabit Ethernet backhaul, with advanced networking capabilities, at the lowest TCO in the industry. EtherHaul™ enables service providers to profitably and reliably provide data intensive services. Provided by Siklu, the pioneer in silicon based mm-waves backhaul systems, EtherHaul™ systems are the perfect choice for future proof investment.

2. EtherHaul™ 614TX System Overview

2.1 Functional Blocks

The EtherHaul™ 614TX is all-outdoor units comprised of the following functional blocks:

- RFIC: Siklu's integrated Silicon Germanium (SiGe) transceiver operating at 57-71 GHz
- Modem/Baseband ASIC: Siklu's modem/baseband ASIC includes the modem, and FEC engines.
- Network Processor: the networking engine is the heart of the high speed bridge/router function. The engine receives packets from both Ethernet interfaces and from the modem. It is responsible for proper forwarding between these three ports.
- Interfaces: The network interface consists of three integrated 100/1000 Ethernet ports.
- Host processor (integrated with the network processor): the general purpose host processor controls the system, and the antenna alignment system.
- Antenna: Siklu's self-designed, innovative antenna.

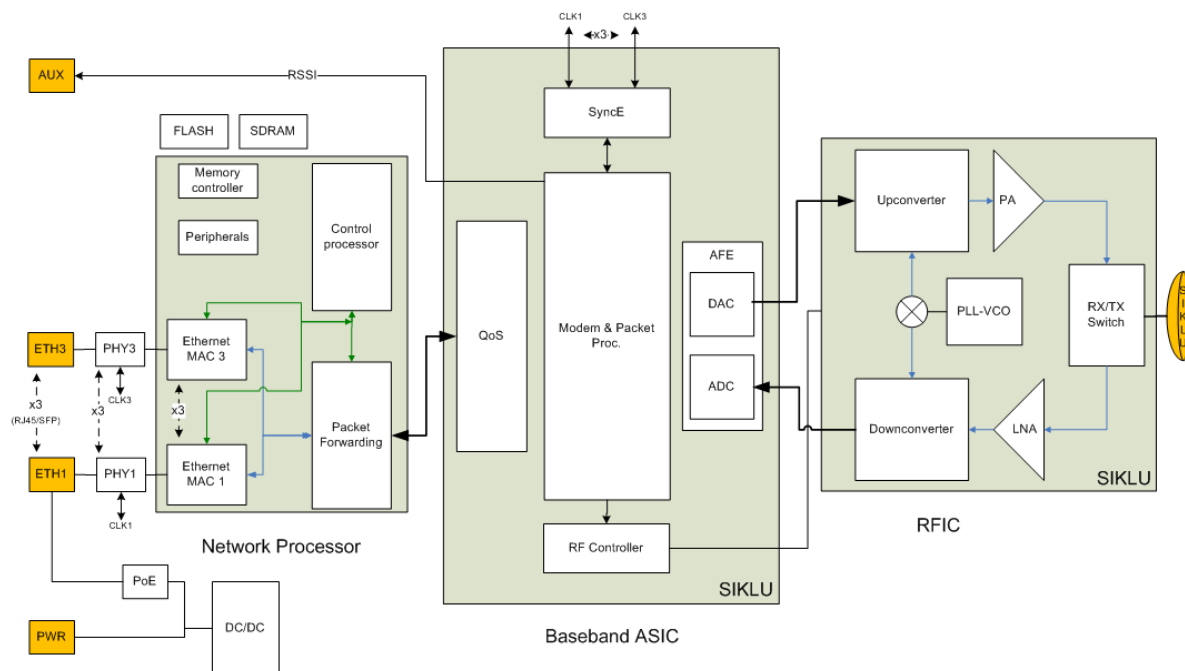

Figure 3 - EtherHaul™ 614TX functional block diagram

2.2 EH-614TX General Specifications

Technology and frequency	TDD, 57-71GHz
Modulation	QPSK-1/QPSK-2/QPSK-3/QAM16/QAM64
Adaptive modulation	Hitless adaptive bandwidth, coding and modulation, boosting system gain by 25dB
Over-the-air throughput	Up to 1000Mbps aggregated (with asymmetric downlink/uplink rate support)
Typical link distance	Up to 1200m (rain zone dependent)
Interfaces	3xGbE copper ports
Antenna	36dBi (typical)
Power options	PoE-In: 26W without PoE-Out; up to 78W with PoE-Out PoE-Out, up to 53W: <ul style="list-style-type: none"> 1. Port 2: 40W, port 3: 13W 2. Port 2: 26W, port 3: 26W 3. Port 2: 52W, port 3: 0W
Ethernet features	VLAN (IEEE 802.1q) and VLAN stacking (Q-in-Q, IEEE 802.1ad Provider Bridge) IEEE 802.1d Transparent Bridging QoS, traffic shaping and policing MEF 9,14 and 21 compliant Ethernet OAM and CFM (IEEE 802.1ag / ITU-T Y.1731 / IEEE 802.3ah) (SW license dependent) Ethernet Ring Protection (ITU-T G.8032) (SW license dependent) Jumbo frames up to 9k
Network topologies	Ring, daisy-chain and mesh
Encryption	AES 128-bit and 256-bit (SW license dependent)
Management	Web GUI (one click management of local & remote units), embedded CLI, SNMPv2/3, in-band, out-of-band Zero-touch turn-up, TACACS+, RADIUS
Environmental	Operating temperature: -45° ÷ +50°C Ingress protection rating: IP67

Regulatory	ETSI EN 302 217, UK IR 2078 & IR 2000, USA FCC Part 15.255, CE marked, EMC, safety UL60950
Dimensions	ODU+ Antenna (H x W x D) – 16.5 cm x 16.5 cm x 10cm
Weight	ODU + antenna: 1.8 kg

Table 1 : Features list

3. EtherHaul™ 614TX product specifications

3.1 Frequency band, channels and modulation schemes

3.1.1 Frequency band

The EtherHaul™ 614TX operates in the 57-71 GHz V-band frequency spectrum. The supported center frequencies¹ are: 57.375, 58.375, 58.875, 59.375, 59.875, 60.375, 62.375, 62.875, 63.875, 64.375, 65.175, 65.675, 66.375 & 66.875GHz.

3.1.2 Channel sizes

The EtherHaul™ 614TX support channel sizes of 125, 250 and 500MHz.

3.1.3 Modulation

The system implements adaptive modulation scheme which includes adaptation of the following system parameters:

- Modulation: 64 QAM, 16 QAM and QPSK (3 levels)
- Channel bandwidth: full bandwidth to 1/4 bandwidth

Mode	Modulation
0	QAM 64
1	QAM 32
2	QPSK
3	QPSK
4	QPSK

Table 2: EH-614TX modulation table

3.1.4 Standard compliance

The EH-614TX complies with both ETSI spectrum channel arrangement and FCC requirements:

- ETSI EN 302 217-3
- UK IR 2078 & IR 2000
- USA FCC Part 15.255

¹ EH-614TX/TX SW adapts the channel plan according to the local radio regulations.

3.1.5 Benefits

The RF parameters are configured using the management software resulting in a minimum service interruption and do not require any manual calibration. This enables rapid, easy and flexible frequency planning and additional cost savings on the occupied spectrum.

Operations in a large number of channels in the 14GHz license-exempt V-band enhances the performance of the EH-614TX in 2 ways:

- Operating in the upper regions of the 60GHz band allows longer distances, as the oxygen absorption effect centered at 62GHz has minimal impact. The EH-614TX will typically reach 50% further operating in the 64 to 71 GHz band, when compared to links deployed in the 57 to 64GHz section.
- The frequency expansion also allows EH-614TX to tune to a wider choice of frequencies, providing additional spectrum for dense deployments.

The high performance design of radio and modem makes possible using spectral efficient modulations like QAM16 and QAM64 to achieve high capacity on the one hand, and to provide a robust connection using strong error correction codes and increased sensitivity, on the other hand.

14 operating frequencies² allow dense mmWave deployments, and more importantly, superior link performance as some channels are located in better spectrum, where the oxygen effect is not as dominant in the link attenuation.

3.2 Radio Specifications

3.2.1 Transmit power, receiver sensitivity, channel capacity

Channel (MHz)	Modulation	Occupied BW (MHz)	Pout (dBm)	Receiver Threshold (dBm @ BER=10 ⁻⁶)	L1 Capacity - Aggregate (Mbps)
500	QAM 64	500	+5	-60	1000
	QAM 16	500	+5	-65	700
	QPSK3	500	+5	-70	350
	QPSK2	250	+5	-76	85
	QPSK1	125	+8	-82	20
250	QAM 64	250	+5	-63	500
	QAM 16	250	+5	-68	350
	QPSK3	250	+5	-73	175
	QPSK2	125	+5	-79	42

² EH-614TX/TX SW adapts the channel plan according to the local radio regulations.

	QPSK1	125	+8	-82	20
125	QAM 64	125	+5	-65	250
	QAM 16	125	+5	-70	175
	QPSK2	125	+5	-75	80
	QPSK1	125	+8	-81	20

Table 3: EH-614TX radio parameters 500MHz channel

3.2.1.1 Benefits

The high performance design of radio and modem enables spectral efficient modulations like QAM16 and QAM64 to achieve high capacity on the one hand, and to provide a robust connectivity using strong error correction codes and increased sensitivity on the other hand.

3.2.2 Transmit power control

The nominal transmit power may be controlled to allow deployment of short distance links. The transmit power may be set in range between +5 dBm (default) to -35 dBm.

When commissioning a link the maximum RSSI should not exceed -35 dBm. If the maximum RSSI is exceeded, the transmit power needs to be reduced until reaching the maximum allowed RSSI.

3.3 Antenna

The EtherHaul™ 614TX has an integrated 14cm self-designed, innovative antenna. The antenna is an integrated, cassegrain reflector, directional antenna and designed for street level installation scenarios and optimized to cope with poles sway and vibration.

Type	Integrated
Diameter	14 cm (5.5")
Gain (typical)	36 dBi
3 dB Beam width (AZ)	2.5°

3 dB Beam width (EL)	2.5°
Radiation Pattern Envelope	Class 2 (ETSI 302 217-4-2 V1.5.1 -2010-01)

Table 4- antenna specifications

3.3.1 Standard compliance

ETSI EN 302 217-4-2 V1.5.1

3.3.2 Benefits

- Integrated antenna results a zero foot print outdoor solution, durable wind load, and easy installation and alignment
- Direct-Mount capability and installation kits extend links physical durability for enhanced performance at tough weather conditions.

3.4 Ethernet interfaces

The EH-614TX includes 3 100/1000 base-T Ethernet ports

Each port can be configured to support:

- Auto negotiation enabled/disabled
- Port speed: 100/1000, HF/FD (100m speed applicable for electrical ports only)
- PoE-Out, on port ETH2 & ETH3

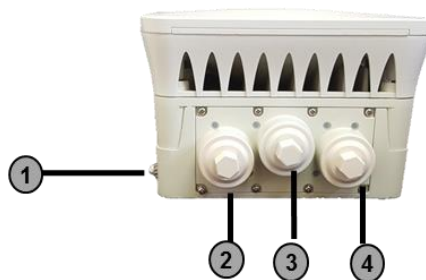

Figure 4 - EtherHaul™ 614TX interfaces

- (1) Ground
Data Interfaces, 3x 100/1000BaseT, RJ-45, and power
- (2) Poe-In

- (3) Poe-Out, up to 52W
- (4) Poe-Out, up to 26W

3.4.1 Standard compliance

100 Base-T/1000 Base-TX (Auto-sensing or fixed)

Connector	RJ-45
Max Segment Length	Up to 100 meters with Cat5e cable

Table 5: 100/1000 Base-T(X)

3.4.2 Benefits

- 3 Ethernet ports are the ideal number of interfaces at a hub or drain site. It enables:
 - Advanced network topologies: ring, mesh and daisy chain
 - Connectivity for more services at each location, reducing the need for external devices for services grooming
- An EtherHaul™ product use standard GE (RJ-45) connectors and does not require any proprietary sealing solution. No propriety cables are needed.
- Each EH-614TX unit kit contains sets of cable gland sealing accessories:
 - Fix connector outlet (3)
 - Fix rubber gasket (2)
 - Fix cable inlet (1) with cable securing holes (designed for standard based strips)
 - In this figure 4, the dotted line (4) represents the cable.

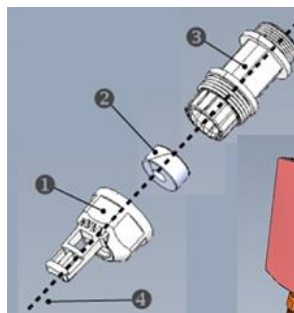

Figure 5 - EtherHaul™ 614TX connector gland assembly

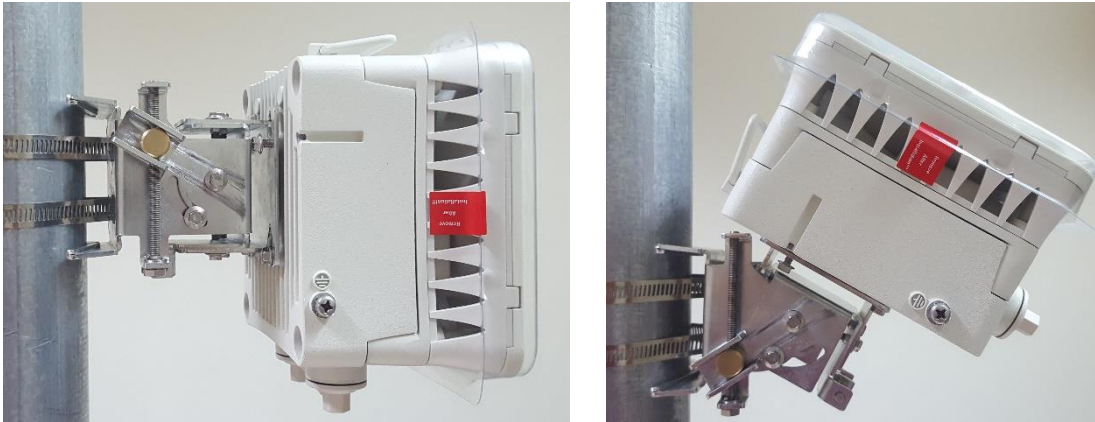

Figure 6 - EH-614TX installed

3.5 System capacity

The EH-614TX products features up to 1 Gbps, aggregated capacity, as detailed in 3.2.1.

3.5.1 Benefits

High capacity allows operators to:

- Fulfill the capacity requirements for mobile backhaul capacities for 3G, LTE and LTE-A ('future proof' solution).
- Provide high capacity broadband services
- Cascades wireless backhaul links between numerous street-level devices such as small-cells, CCTV cameras, Wi-Fi access points and others.
- Deliver multiple services, all with max capacity at same location.

3.6 Adaptive modulation

The EH-614TX implements hitless/errorless adaptive bandwidth, coding and modulation adjustment to optimize the over-the-air transmission and prevent weather-related fading from causing traffic on the link to be disrupted. The EtherHaul™ products can

gain up to 25 dB in link budget by dynamically adapting: Modulation, FEC coding rates and channel bandwidth dropping the traffic according to the QoS priority.

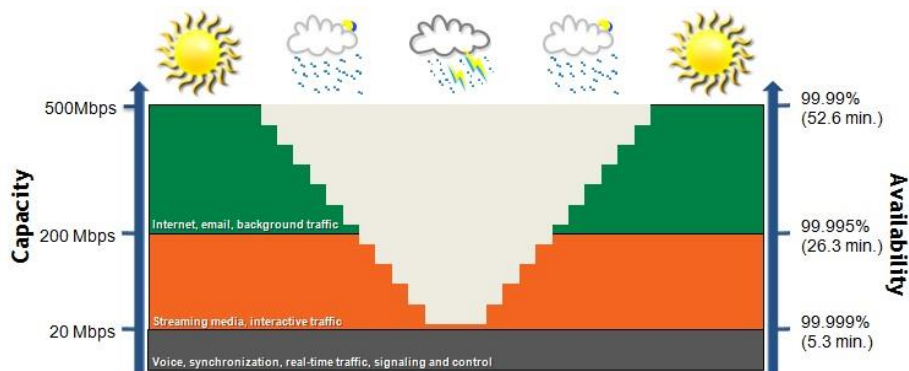

Figure 7 - Hitless Adaptive Bandwidth, Coding and Modulation

3.6.1 Benefits

- Adaptive bandwidth, coding and modulation ensures maximum capacity most of the time with guaranteed high priority services all the time.
- The solution's hitless algorithm ensures zero down time to enable a constant flow of voice and real-time services allowing carriers to meet their service commitments for enhanced user experience.

3.7 Asymmetrical uplink/downlink ratio configuration

The EtherHaul™ 614TX operates in Time Division Duplexing (TDD) mode, allowing both symmetric and asymmetric traffic mode (network operator configurable).

The asymmetrical traffic may be configured at downstream-upstream ratio of:

- 75%-25%

3.7.1 Benefits

- Time division multiplexing simplifies system design lowers cost and allows asymmetrical traffic management.
- TDD is the optimal choice for the 60GHz band.
- Being able to divide the traffic asymmetrically is a more efficient use of the spectrum as the last mile traffic tends to be asymmetric in nature

- The TDD throughput may be divided asymmetrically between the downlink and uplink. This means that the spectrum is utilized more effectively, especially in last mile applications where the traffic is often asymmetric in nature reaching a de-facto uplink: downlink ratio of 1:5 or 1:6. For example, using the TDD radio may divide the 1000Mbps asymmetrically, such that 750Mbps is allocated to the downlink and only 250Mbps is allocated to the uplink. => 40% saving in channel usage

3.8 Alignment

The EH-614TX must be aligned on both local and remote unit. The course alignment performed on each ODU, followed by fine alignment. Accurate alignment of the ODU is essential for achieving the strongest possible receive signal.

In order to perform antenna alignment, the ODU must be in Alignment Mode, either using CLI/Web or by just plugging the probes of the voltmeter into a dedicated alignment connector.

Dividing the DVM millivolt output by 10 will provide the actual receive signal strength calculation (RSSI). For example, a DVM millivolt reading of 450 mV is equivalent to -45 dBm.

3.8.1 Benefits

- Simple and reliable antenna alignment process (no computer connection is needed)
- Simple RSSI indication conversion
- The alignment is done using standard tools with the EH-614TX mounting kit

3.9 Power

3.9.1 Input Power

The EH-614TX has the following power input:

- PoE++ (IEEE 802.3at+) over port ETH1, with a power draw of 26W without PoE-Out; up to 78W with PoE-Out active.

3.9.1.1 Benefits

Thanks to the efficient system design and high integration, the EH-614TX:

- Reduces the power consumption and accordingly the associated energy costs.
- Simplifies the installation scenario, by enabling use of a single cable for both power and data.

3.9.2 Poe-Out

The EH-614TX has the following PoE-Out options:

1. Port 2: 40W, port 3: 13W
2. Port 2: 26W, port 3: 26W
3. Port 2: 52W, port 3: 0W

3.9.2.1 Benefits

The integration of Poe-Out capability with the EH-614TX greatly simplifies deployment and installation of collocated devices:

- Simplifies the installation scenario, by enabling use of a single cable for both the EtherHaul™ 600T and the devices it serves, such as surveillance cameras, Wi-Fi Access Points or small cells.
- Reduces the equipment requirements at the site by eliminating the need for additional power sources.
- Reduces the installation time and material, when the data cable from the EH-614TX brings connectivity and power to the served equipment.

4. Networking capabilities and features

The following networking features and more are reviewed in the companion document "EtherHaul™ System Description": Switching, QoS, Link OAM & CFM, Ethernet Ring Protection (ERP).

5. Management concept

The following management concepts and more are reviewed in the companion document "EtherHaul™ System Description": Web GUI, CLI, SNMP, FTP, and User Access & Rights Management.

6. Security

The following security aspects and more are reviewed in the companion document "EtherHaul™ System Description": physical security, link layer encryption, management security and secure interfaces to 3rd party managers.

7. Logging and auditing features

The logging and auditing capabilities of the EtherHaul™ 614TX are discussed in the companion document "EtherHaul™ System Description".

8. Diagnostic tools

The diagnostic tools of the EtherHaul™ 614TX are reviewed in the companion document "EtherHaul™ System Description".

9. EtherHaul™ Deployment Topologies

The topologies supported by the EtherHaul™ 614TX are explained in the companion document "EtherHaul™ System Description".

10. List of supported standards by EtherHaul

The list of standards and recommendations supported by EtherHaul™ 600T:

- Antennas: ETSI EN 302 217-4 Class2
- Frequency Regulations:
 - ETSI EN 302 217-3
 - UK IR 2078 & IR 2000
 - USA FCC Part 15.255

Management (reference also to Security)

- IEEE 802.1ab - Link Layer Discovery Protocol (LLDP)
- IEEE 802.1ag – Connectivity Fault Management (CFM)
- IEEE 802.3ah - Ethernet in the first mile (EFM), OAM
- ITU-T Y.1731- OAM functions and mechanisms for Ethernet based networks
- RFC 1157 SNMPv2/3
- RFC 2131 - Dynamic Host Configuration Protocol
- RFC2819 – RMON Remote Network MONitoring

Security

- IETF TACACS+
- RADIUS
- RFC 2246 - Transport Layer Security (TLS) protocol
- RFC 2818 – HTTPS, HTTP over TLS
- RFC 4251 - the IETF extension of the Secure Shell protocol (SSH) version 2.0
- RFC 913 SFTP, SFTTP, TFTP
- U.S. FIPS PUB 197 (FIPS 197), AES with 128/256 bits
- RFC2616 - Hypertext Transfer Protocol (HTTP)

Networking

- IEEE 802.1ad Provider Bridge – QinQ VLAN/VLAN stacking
- IEEE 802.1ax, LAG / LACP
- IEEE 802.1d Transparent Bridge
- IEEE 802.3ab / Ethernet 1000BASE-T
- ITU-T G.8032 Ethernet Ring Protection Switching
- MEF 21, UNI Type 2, Link OAM
- MEF 9,14
- RFC-2475 - Architecture for differentiated services.
- RFC-5865 - A differentiated services code point (DSCP) for capacity-admitted traffic
- Traffic management: 802.1p (L2), DSCP (L3) & MPLS EXP (L2.5)

Environmental, Power

- CE: CE Marked
- EMC: EN 301 489-4; FCC 47 CFR part 15
- IEEE 802.3af or 802.3at PoE power source (model dependent)
- IEEE 802.3at++ PoE power(ed) device (model dependent)
- Ingress Protection Rating: IP67
- MSA SFP INF-8074 Small Form Factor Pluggable
- Operation: EN 300 019-1-4 Class 4.1E
- Safety: UL 60950
- Storage: EN 300 019-1-1 Class 1.2
- Transportation: EN 300 019-1-2 Class 2.2

11. References

- [1] Siklu' EtherHaul™ System Description, Release 3.0, August 2018 or later edition

About Siklu

Siklu delivers Gigabit capacity millimeter wave wireless backhaul solutions operating in the 60, 70 and 80 GHz bands. Ideal for dense, capacity-hungry urban security networks, the ultra-high capacity wireless links can be easily and discreetly installed on the very same street fixtures as the security cameras. The most deployed mmW radios in the world, thousands of units are delivering carrier grade performance in varying weather conditions around the world.

Siklu Communication Ltd.
43, HaSivim St.
Petach Tikva 49517, Israel
Tel: +972 72 2454100
Fax: +972 3 921 4162
hello@siklu.com