



EH-500TX

Product Description

June 2016

Release: 1.0

Table of Contents

1. Introduction	5
2. EtherHaul-500TX System Overview	8
2.1 Functional Blocks	8
2.2 General Specifications	9
3. Product specifications	11
3.1 Frequency band, channels and modulation schemes	11
3.1.1 Frequency band	11
3.1.2 Channel sizes	11
3.1.3 Modulation	11
3.1.4 Standard compliance	11
3.1.5 Benefits	12
3.2 Radio Specifications	12
3.2.1 Transmit power and receiver sensitivity	12
3.2.2 Transmit power control	13
3.3 Antenna	13
3.3.1 Standard compliance	14
3.3.2 Benefits	14
3.4 Ethernet interfaces	14
3.4.1 Standard compliance	15
3.4.2 Benefits	15
3.5 System capacity	16

EtherHaul-500TX Product Description

3.5.1 Benefits	16
3.6 Adaptive modulation	17
3.6.1 Benefits	17
3.7 Asymmetrical uplink/downlink ratio configuration.....	17
3.7.1 Benefits	17
3.8 Alignment	18
3.8.1 Benefits	18
4. Networking capabilities and features	19
4.1 Switching	19
4.1.1 QoS-Aware Transparent Bridge (IEEE 802.1d)	19
4.1.2 Provider Bridge (IEEE 802.1ad).....	19
4.1.3 Standards compliance	21
4.1.4 Benefits	21
4.2 Quality of service (QoS)	22
4.2.1 Classification and Policing.....	22
4.2.2 Buffer size	23
4.2.3 Scheduling Mechanisms	24
4.2.4 Standard compliance	24
4.2.5 Benefits	25
4.3 Queue management - WRED	25
4.3.1 WRED Benefits.....	26
4.4 LAG / LACP	26
4.4.1 Standard compliance	26
4.4.2 Benefits	26
4.5 Configurable Ethertype	26
4.5.1 Benefits	26
4.6 LLDP.....	27
4.6.1 Standard compliance	27

EtherHaul-500TX Product Description

4.6.2 Benefits	27
4.7 lperf	27
4.7.1 Benefits	28
4.8 DHCP	28
4.8.1 Standard compliance	28
4.8.2 Benefits	28
4.9 Link OAM	28
4.9.1 Standard compliance	29
4.9.2 Benefits	29
4.10 Connectivity Fault Management (CFM)	29
4.10.1 Standard compliance	31
4.10.2 Benefits.....	31
4.11 Performance monitoring OAM.....	32
4.11.1 Standard compliance.....	32
4.11.2 Benefits.....	32
4.12 ITU-T G.8032 Ethernet Ring Protection (Resiliency)	32
4.12.1 Standard compliance.....	33
4.12.2 Benefits.....	33
4.13 Ethernet Synchronization	35
4.13.1 Synchronous Ethernet (ITU-T G.8261).....	35
4.13.2 1588 Transparent Clock	36
4.13.3 1588 optimization.....	36
5. Management concept.....	37
5.1 CLI	38
5.1.1 Benefits	38
5.2 Web GUI	39
5.2.1 GUI main screen	39
5.2.2 Quick configuration wizard	40

EtherHaul-500TX Product Description

5.2.3 Standard compliance	41
5.2.4 Benefits	41
5.3 SNMP	42
5.3.1 Standard compliance	42
5.3.2 Benefits	42
5.4 FTP/SFTP/TFTP	42
5.4.1 Standard compliance	42
5.4.2 Benefits	42
5.5 User management	43
5.5.1 Local/Remote user management	43
5.5.2 Radius and TACACS+ user management.....	43
5.5.3 Benefits	44
6. Security	44
6.1 Security features description	44
6.2 Interface to external access rights management systems	45
7. Logging and auditing features	46
7.1 System alarms and events	46
7.2 System statistics	50
7.2.1 Benefits	51
7.2.2 Standard compliance	51
7.3 System loopbacks	51
7.3.1 Benefits	52
8. Power supply	52
8.1.1 DC power supply	52
8.1.2 Benefits	52
9. EtherHaul Deployment Topologies	52
9.1 Point to point.....	54
9.2 Daisy Chain, Ring and Mesh topology connection	54

9.2.1 Solution benefits	55
10. List of supported standards by EtherHaul	55

1. Introduction

The EtherHaul-500TX (EH-500T) radio delivers carrier-grade wireless point-to-point gigabit Ethernet services utilizing the 57-66 GHz unlicensed V-band spectrum. The solution is designed and optimized for street level connectivity including small cell backhaul, security and CCTV wireless networks, Wi-Fi backhaul and other applications. The EH-500TX on one hand meets the stringent requirements of service providers while on the other hand allows easy installation by non-Telco professional staff.

The EH-500TX is based on Siklu's revolutionary integrated-silicon technology, which results in a highly reliable, zero footprint, and low-cost radio.

The EH-500TX offers Gigabit throughput, MEF-compliant networking, 8 levels of QoS, enhanced hitless adaptive bandwidth, coding & modulation for maximum spectral efficiency, and services availability. It supports network synchronization, advanced OAM&PM tools and ring protection optimized for both small cell and mobile backhaul applications. It features multiple GbE interfaces, including optical, supporting complex network topologies, such as daisy chain, ring, and mesh. The multiple ports enable also colocation installation and leveraging the infrastructure for additional fixed services delivery. All in a very small and light outdoor package that is optimized for street level installations and designed to overcome pole sway, twist and/or tilt. The EH-500TX is fast, simple and inexpensive to deploy.

EH-500TX is well suited for street-level connectivity and includes the following features:

- **Field proven technology**
- **Reduced TCO and fast ROI**
- **All-outdoor invisible footprint**
 - **Small and light**
 - **Quick and easy to install**
- **Optimized for street level deployments**
 - **Works on poles, buildings facades (walls), traffic lights and more**
 - **Designed to overcome sway, twist and/or tilt**
- **Spectral efficient**
 - **Wide range of frequencies**
 - **TDD modulation with seamless delay and jitter**

EtherHaul-500TX Product Description

- Hitless adaptive bandwidth coding and modulation for high availability
- **Advanced layer-2 features:**
 - MEF-compliant services and QoS
 - VLAN & Provider Bridge with 9K jumbo frames support
 - Clear separation between multiple services with QoS
 - Enables QoS aware MPLS services delivery
 - SLA assurance
- **Advanced AES encryption for secured street level deployments**

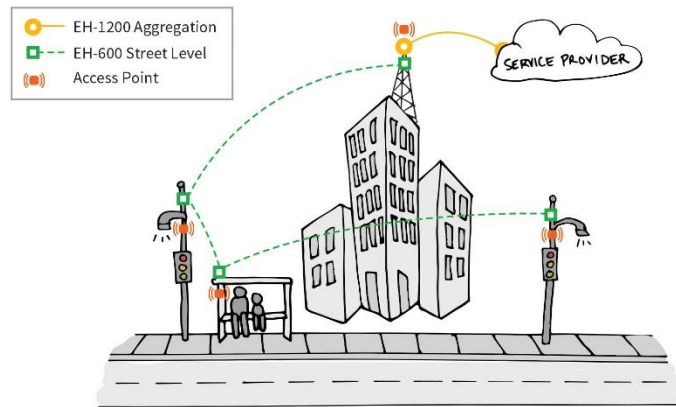

Figure 1 - Street level backhaul on various types of street furniture

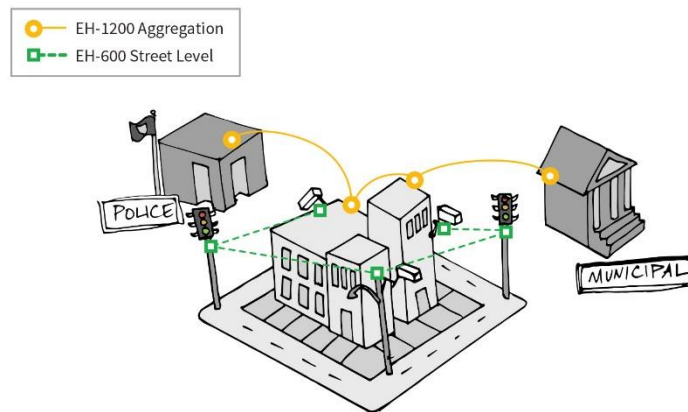

Figure 2 - street level security camera connectivity

Easily integrated into service-provider networks, out-of-the-box up & running capable. Highly-scalable, the EtherHaul products are software-upgradable to support future networking and routing capabilities as networks evolve.

EtherHaul-500TX Product Description

The EtherHaul products features advanced adaptive modulation, bandwidth and coding - allowing operators to maintain, prioritize, and verify QoS in all weather conditions, while achieving maximum (up to 99.999%) link availability for prioritized services such as voice signaling and SynC.

Offering easy and low cost all-outdoor installation and a small form factor, the EtherHaul products are also environmentally-friendly - boasting a small system and antenna footprint with especially low power consumption.

The EtherHaul systems are High-capacity Gigabit Ethernet backhaul, with advanced networking capabilities, at the lowest TCO in the industry. EtherHaul enables service providers to profitably and reliably provide data intensive services. Provided by Siklu, the pioneer in silicon based mm-waves backhaul systems, EtherHaul systems are the perfect choice for future proof investment.



info@siklu.com
www.siklu.com

2. EtherHaul-500TX System Overview

2.1 Functional Blocks

The EtherHaul-500TX is all-outdoor units comprised of the following functional blocks:

- a. **RFIC:** Siklu's integrated Silicon Germanium (SiGe) transceiver operating at 57-66 GHz
- b. **Modem/Baseband ASIC:** Siklu's modem/baseband ASIC includes the modem, FEC engines, and Synchronous Ethernet support.
- c. **Network Processor:** the networking engine is the heart of the high speed bridge/router function. The engine receives packets from both Ethernet interfaces and from the modem. It is responsible for proper forwarding between these three ports.
- d. **Interfaces:** The network interface consists of three integrated 100/1000 Ethernet ports.
- e. **Host processor (integrated with the network processor):** the general purpose host processor controls the system, and the antenna alignment system.
- f. **Antenna:** Siklu's self-designed, innovative antenna.

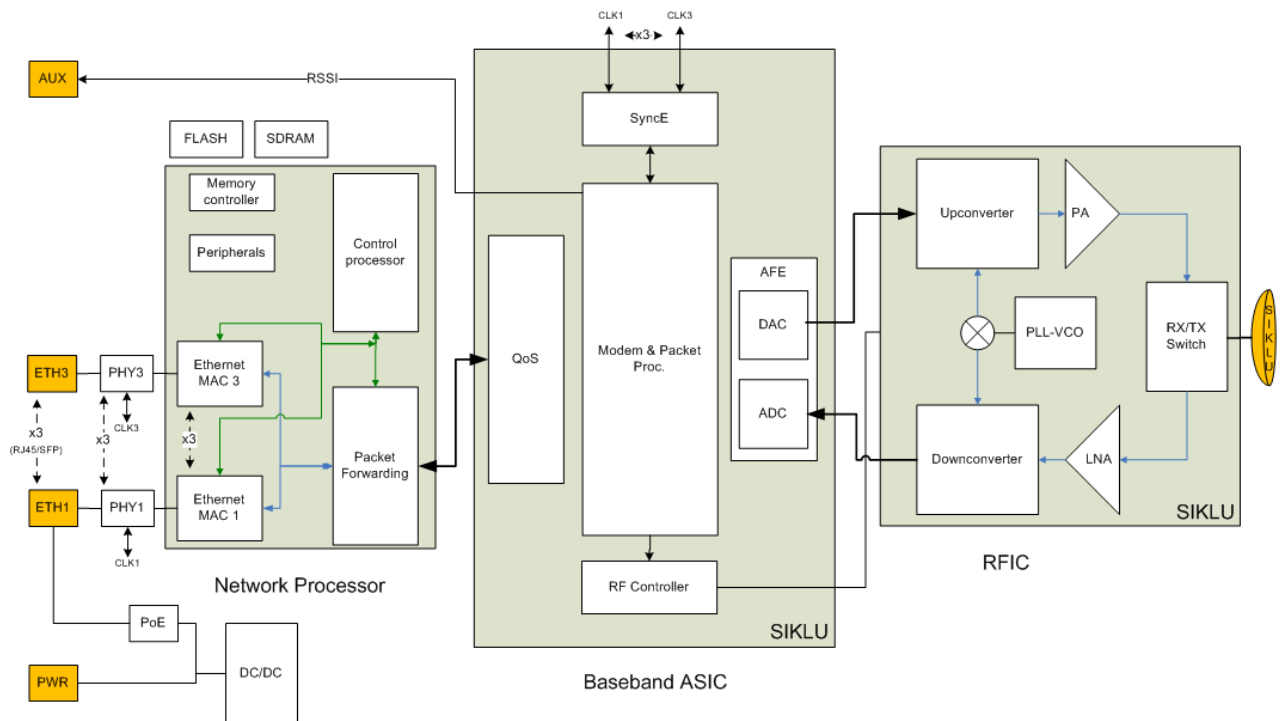

Figure 3 - EtherHaul-500TX functional block diagram

2.2 General Specifications

Technology and frequency	TDD, 57-66GHz
Modulation	QPSK-1/QPSK-2/QPSK-3/QAM16/QAM64
Adaptive modulation	Hitless adaptive bandwidth, coding and modulation, boosting system gain by 25dB
Over-the-air throughput	Up to 200Mbps aggregated (with asymmetric downlink/uplink rate support)
Typical link distance	Up to 1000m
Interfaces	3xGbE copper ports
Antenna	36dBi (typical)
Power options	<p>PoE IN</p> <p>PoE out – up to 53W :</p> <ol style="list-style-type: none"> 1. Port 2: 40W, port 3:13W 2. Port 2:26W, port 3: 26W
Ethernet features	<p>VLAN (IEEE 802.1q) and VLAN stacking (Q-in-Q, IEEE 802.1ad Provider Bridge)</p> <p>IEEE 802.1d Transparent Bridging</p> <p>QoS, traffic shaping and policing</p> <p>MEF 9,14 and 21 compliant</p> <p>Ethernet OAM and CFM (IEEE 802.1ag / ITU-T Y.1731 / IEEE 802.3ah)</p> <p>Ethernet Ring Protection (ITU-T G.8032)</p> <p>Jumbo frames up to 16k</p>
Synchronization	<p>IEEE 1588v2 TC</p> <p>Synchronous Ethernet ITU-T G.8261/8262/8264</p>
Network topologies	Ring, daisy-chain and mesh
Encryption	AES 128-bit and 256-bit
Management	<p>Web GUI (one click management of local & remote units), embedded CLI, SNMPv2/3, in-band, out-of-band</p> <p>Zero-touch turn-up, TACACS+, RADIUS</p>
Environmental	<p>Operating temperature: -45° ÷ +50°C</p> <p>Ingress protection rating: IP67</p>

EtherHaul-500TX Product Description

Regulatory	ETSI EN 302 217, UK IR 2078 & IR 2000, USA FCC Part 15.255, CE marked, EMC, safety UL60950
Dimensions	ODU+ Antenna (H x W x D) – 16.5 cm x 16.5 cm x 10cm
Weight	ODU + antenna: 1.8 kg

Table 1 : Features list

3. Product specifications

3.1 Frequency band, channels and modulation schemes

3.1.1 Frequency band

The EtherHaul-500TX operates in the 57-66 GHz V-band frequency spectrum¹. The supported center frequencies are: 57375, 58375, 58875, 59375, 59875, 60375, 62375, 62875, 63875, 64375 and 65175 MHz.

3.1.2 Channel sizes

The EtherHaul-500TX support channel sizes of 125, 250 and 500MHz.

3.1.3 Modulation

The system implements adaptive modulation scheme which includes adaptation of the following system parameters:

- Modulation: 64 QAM, 16 QAM and QPSK (3 levels)
- Channel bandwidth: full bandwidth to 1/4 bandwidth

Mode	Modulation
0	QAM 64
1	QAM 32
2	QPSK3
3	QPSK2
4	QPSK1

Table 2: EH-500TX modulation table

3.1.4 Standard compliance

The EH-500TX complies with both ETSI spectrum channel arrangement and FCC requirements:

- ETSI EN 302 217-3
- UK IR 2078 & IR 2000

¹ Consult your Siklu sales partner about the V-band spectrum and specific frequencies regulated in your local country.

- USA FCC Part 15.255

3.1.5 Benefits

The RF parameters are configured using the management software resulting in a minimum service interruption and doesn't require any manual calibration. This enables rapid, easy and flexible frequency planning and additional cost savings on the occupied spectrum.

The high performance design of radio and modem makes possible using spectral efficient modulations like QAM16 and QAM64 to achieve high capacity on the one hand, and to provide a robust connection using strong error correction codes and increased sensitivity, on the other hand.

3.2 Radio Specifications

3.2.1 Transmit power and receiver sensitivity

Channel (MHz)	Modulation	Occupied BW (MHz)	Pout (dBm)	Receiver Threshold (dBm @ BER=10 ⁻⁶)	L1 Capacity - Aggregate (Half Duplex) (Mbps)
500	QAM 64	500	+5	-60	1000
	QAM 16	500	+5	-65	700
	QPSK3	500	+5	-70	350
	QPSK2	250	+5	-76	85
	QPSK1	125	+8	-82	20
250	QAM 64	250	+5	-63	500
	QAM 16	250	+5	-68	350
	QPSK3	250	+5	-73	175
	QPSK2	125	+5	-79	42
	QPSK1	125	+8	-82	20
125	QAM 64	125	+5	-65	250
	QAM 16	125	+5	-70	175
	QPSK2	125	+5	-75	80
	QPSK1	125	+8	-81	20

Table 3: EH-500TX radio parameters 500MHz channel

3.2.1.1 Benefits

The high performance design of radio and modem enables spectral efficient modulations like QAM16 and QAM64 to achieve high capacity on the one hand, and to provide a robust

connectivity using strong error correction codes and increased sensitivity on the other hand.

3.2.2 Transmit power control

The nominal transmit power may be controlled to allow deployment of short distance links. The transmit power may be set in range between +5 dBm (default) to -35 dBm.

When commissioning a link the maximum RSSI should not exceed -35 dBm. If the maximum RSSI is exceeded, the transmit power needs to be reduced until reaching the maximum allowed RSSI.

3.3 Antenna

The EtherHaul-500TX has an integrated 14cm self-designed, innovative antenna. The antenna is an integrated, cassegrain reflector, directional antenna and designed for street level installation scenarios and optimized to cope with poles sway and vibration.

Type	Integrated
Diameter (cm)	14 cm (5.5")
Gain (dBi)	36 (typical)
3 dB Beam width (AZ)	2.5°
3 dB Beam width (EL)	2.5°
Radiation Pattern Envelope	Class 2 (ETSI 302 217-4-2 V1.5.1 - 2010-01)

Table 4- antenna specifications

3.3.1 Standard compliance

ETSI EN 302 217-4-2 V1.5.1

3.3.2 Benefits

- Integrated antenna results a zero foot print outdoor solution, durable wind load, and easy installation and alignment
- Direct-Mount capability and installation kits extend links physical durability for enhanced performance at tough weather conditions.

3.4 Ethernet interfaces

The EH-500TX includes 3 100/1000 base-T Ethernet ports as seen on Figure 4. Each port can be configured to support:

- Auto negotiation enabled/disabled
- Port speed: 100/1000, HF/FD

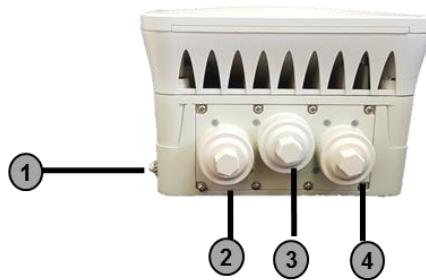

Figure 4 - EtherHaul-500TX interfaces

Legend:

- GND (1)
- Data Interfaces: 3x RJ-45 for 100/1000Base-T (3,4,5)
- Power: PoE++In (2), PoE++Out (3,4)

3.4.1 Standard compliance

IEEE	100 Base-T/1000 Base-TX (Auto-sensing or fixed)
Connector	RJ-45
Max Segment Length	Up to 100 meters with Cat5e cable

Table 5: 100/1000 Base-T(X)

3.4.2 Benefits

- **3 Ethernet ports are the ideal number of interfaces at a hub or drain site. It enables:**
 - **Advanced network topologies: ring, mesh and daisy chain**
 - **Connectivity for more services at each location, reducing the need for external devices for services grooming**
- **An EtherHaul product use standard GE (RJ-45) connectors and does not require any proprietary sealing solution. No propriety cables are needed.**
- **Each EH-500TX unit kit contains sets of cable gland sealing accessories:**
 - **Fix connector outlet (3)**
 - **Fix rubber gasket (2)**
 - **Fix cable inlet (1) with cable securing holes (designed for standard based strips)**
 - **In this Figure 5, the dotted line (4) represents the cable.**

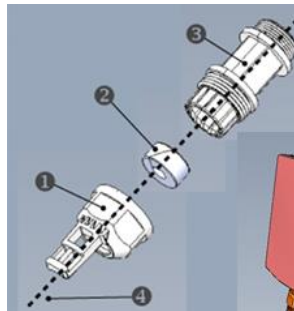

Figure 5 - EtherHaul-500TX connector gland assembly

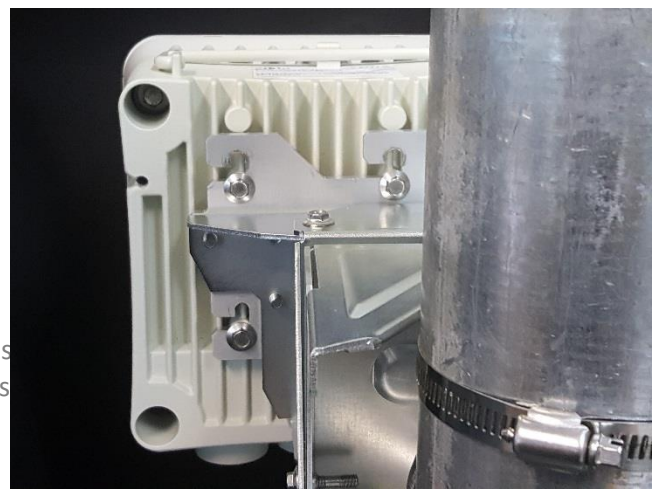
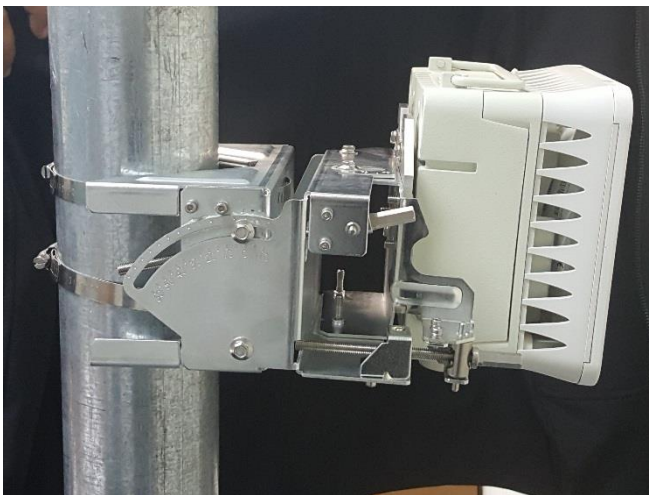

Figure 6 - EH-500TX installed

3.5 System capacity

The EH-500TX products features up to 1 Gbps, aggregated capacity.

Channel (MHz)	Modulation	Occupied BW (MHz)	L1 Capacity - Aggregate (Half Duplex) (Mbps)
500	QAM 64	500	1000
	QAM 16	500	700
	QPSK3	500	350
	QPSK2	250	85
	QPSK1	125	20

Table 6: Capacity for 500 MHz channel

Notes:

- (1) Aggregated capacity. Capacity may be divided at a ratio of: 50%-50% downstream-upstream, 75%-25% downstream-upstream.
- (2) Capacity varies according to packet size.

3.5.1 Benefits

High capacity allows operators to:

- Fulfill the capacity requirements for mobile backhaul capacities for 3G, LTE and LTE-A ('future proof' solution).
- Provide high capacity broadband services
- Cascades wireless backhaul links between numerous street-level devices such as small-cells, CCTV cameras, Wi-Fi access points and others.
- Deliver multiple services, all with max capacity at same location.

3.6 Adaptive modulation

The EH-500TX implements hitless/errorless adaptive bandwidth, coding and modulation adjustment to optimize the over-the-air transmission and prevent weather-related fading from causing traffic on the link to be disrupted. The EtherHaul products can gain up to 25 dB in link budget by dynamically adapting: Modulation, FEC coding rates and channel bandwidth dropping the traffic according to the QoS priority.

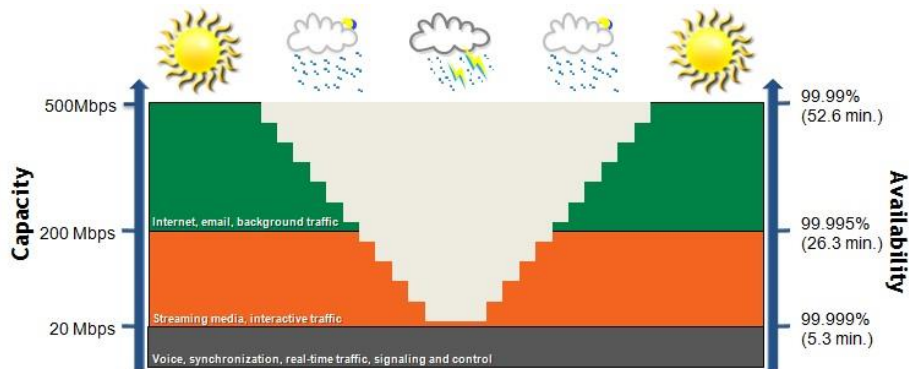

Figure 7 - Hitless Adaptive Bandwidth, Coding and Modulation

3.6.1 Benefits

- Adaptive bandwidth, coding and modulation ensures maximum capacity most of the time with guaranteed high priority services all the time.
- The solution's hitless algorithm ensures zero down time to enable a constant flow of voice and real-time services allowing carriers to meet their service commitments for enhanced user experience.

3.7 Asymmetrical uplink/downlink ratio configuration

The EtherHaul-500TX operates in Time Division Duplexing (TDD) mode, allowing both symmetric and asymmetric traffic mode (network operator configurable).

The asymmetrical traffic may be configured at downstream-upstream ratio of:

- 75%-25%

3.7.1 Benefits

- Time division multiplexing simplifies system design lowers cost and allows asymmetrical traffic management.
- TDD is the optimal choice for the 60GHz band.

- Being able to divide the traffic asymmetrically is a more efficient use of the spectrum as the last mile traffic tends to be asymmetric in nature
- The TDD throughput may be divided asymmetrically between the downlink and uplink. This means that the spectrum is utilized more effectively, especially in last mile applications where the traffic is often asymmetric in nature reaching a de-facto uplink: downlink ratio of 1:5 or 1:6. For example, using the TDD radio may divide the 1000Mbps asymmetrically, such that 750Mbps is allocated to the downlink and only 250Mbps is allocated to the uplink. => 40% saving in channel usage

3.8 Alignment

The EH-500TX must be aligned on both local and remote unit. The coarse alignment performed on each ODU, followed by fine alignment. Accurate alignment of the ODU is essential for achieving the strongest possible receive signal and peak performance.

In order to perform antenna alignment, the ODU must be in Alignment Mode, by just plugging the probes of the voltmeter into the alignment connector.

Dividing the DVM millivolt output by 10 will provide the actual receive signal strength calculation (RSSI). For example, a DVM millivolt reading of 450 mV is equivalent to -45 dBm.

3.8.1 Benefits

- Simple and reliable antenna alignment process (no computer connection is needed)
- Simple RSSI indication conversion
- The alignment is done using standard tools with the EH-500TX mounting kit

4. Networking capabilities and features

4.1 Switching

4.1.1 QoS-Aware Transparent Bridge (IEEE 802.1d)

The out-of-the-box configuration of the EH-500TX is the advanced transparent bridge mode (IEEE 802.1d), a zero-touch judicious match for simple networks. Quality-of-Service-awareness operation is automatic in in this mode. Transparent forwarding of both tagged and untagged traffic is performed. It is possible to allocate a dedicated VLAN for in-band management.

4.1.2 Provider Bridge (IEEE 802.1ad)

Alternatively, the EH-500TX incorporates a full Provider Bridge mode of operation (IEEE 802.1ad). Provider Bridge, commonly known as Q in Q, extends the IEEE 802.1Q standard by providing for a second stack of VLANs in a bridged network.

This enable servicing multiple customers on the same port (user network interface, i.e. Eth1-4) and forwarding (or tunneling) through the radio link (acts as NNI – network network interface) using Service VLAN (S-VLAN). The system is able to deliver multiple S-VLANs, and to allocate in each several customers' VLANs (C-VLAN). Sample VLAN encapsulations are brought in Figure 8.

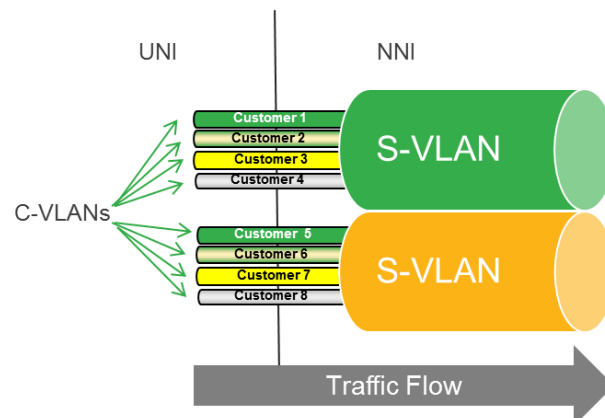

Figure 8: C-VLANs encapsulated in S-VLANs

The provider bridge, which may consist of multiple devices in the service provider domain, looks like a simple bridge port to the customer's traffic and maintains the Customer's VLANs (C-VLAN) with their ID number.

The implementation of Provider Bridge in EtherHaul™ is a network of up to five virtual bridges connected in a “cross-like” fashion as shown in “Figure 9: Provider Bridge Architecture”

- Each component acts as a virtual bridge. A component can have both external and internal ports.
- An external port name is identical to its interface name.
- An internal port name uses the name of its peer component.
- The operator can change the default bridge configuration to suit his network by removing or adding the desired bridge components.
- All components are created, managed, and removed using both CLI and WEB GUI.

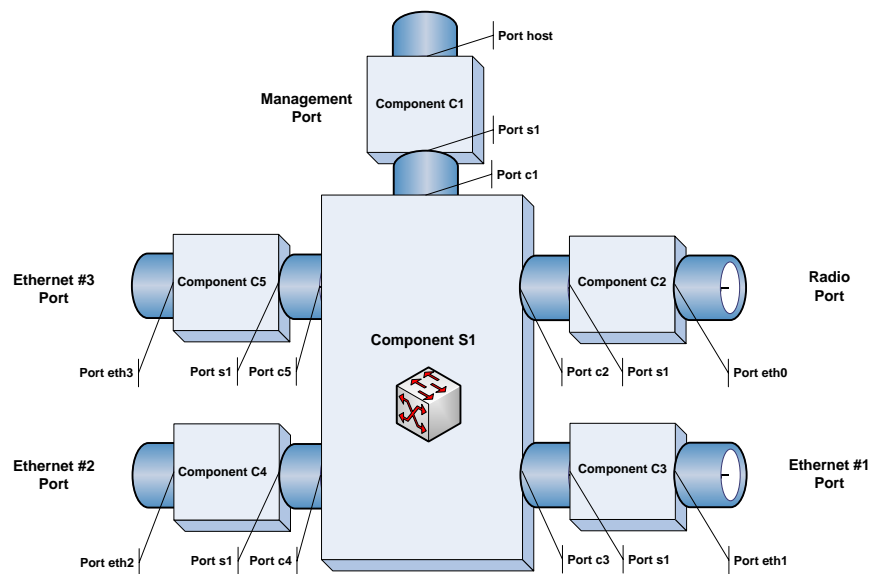

Figure 9- Provider Bridge Architecture*

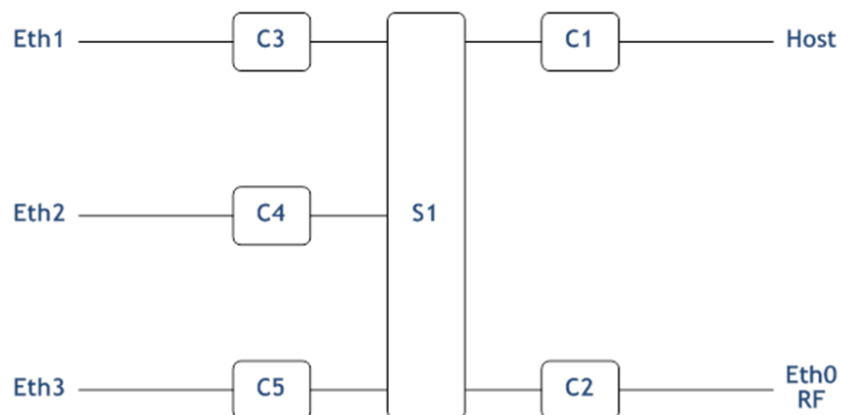

Figure 10- Generic Model of the EtherHaul™ Bridge

Each component acts as a virtual bridge. A component can have both external and internal ports. An external port name is identical to its interface name. An internal port name uses the name of its peer C-component 1 is connected to the S-component, the corresponding internal port in.

For example, the C-component is called S1 and the corresponding internal port in the S-component is called C1.

You can change the default bridge configuration to suit your network by removing or adding the desired bridge components. All components are created, managed, and removed using the CLI.

4.1.3 Standards compliance

- IEEE 802.1d - MAC Bridges
- IEEE 802.1Q - Virtual LANs (VLANs)
- IEEE 802.1ad – QinQ
- Metro Ethernet Forum (MEF) recommendations and defined services: MEF 9, Ethernet Services Functionality:
 - E-LINE, E-LAN and E-TREE services
 - E-LINE with multiple user defined options:
 - Port based
 - Port with single VLAN
 - Port with double VLAN (QinQ)
 - E-LAN with multiple user defined options:
 - MAC
 - VLAN
 - Double VLAN (QinQ)
 - Multiple isolated E-LAN services – by multiple isolated MAC tables
 - E-Tree with multiple user defined options:
 - Port based
 - Port with single VLAN
 - Port with double VLAN (QinQ)
 - UNI attributes, Service frame delivery, VLAN tag support

4.1.4 Benefits

- Flexible networking topologies support
- Carrier class services, following leading standards with proven interoperability

- **Integrated Gigabit Ethernet switch and advanced networking features allows all outdoor installation**
- **The EH-500T's provider bridge is an easy and fast deployment enabler:**
 - **It takes any Ethernet based stream, wraps it with service provider tag**
 - **Enhanced QOS marking based routing of ingress traffic into multiple differentiated queues.**
 - **No limits on frame size (the EtherHaul™ systems supports 16K jumbo frames)**

4.2 Quality of service (QOS)

There are 2 main motives to leverage QOS in a street-level wireless backhaul system:

1. **QOS complements hitless adaptive bandwidth, coding, and modulation mechanisms with real time prioritization of several services. It allows ensuring performance and availability correlated with provider's SLA (service level agreement).**
2. **Enforcing QOS enables carriers to oversubscribe wireless links will supporting the SLA agreement of each individual service, and thus leads to enhanced ROI.**

The EH-500T, equipped with a powerful network processor and Siklu's proven EtherHaul™ advanced software package, enables any service provider to offer best in class differentiated services. With 8 queues, the EH-500TX has QoS granularity for the most demanding environment.

4.2.1 Classification and Policing

The EtherHaul™ QoS engine classifies the incoming packets onto streams using any combination of:

1. **VLAN number (VID) – prioritizes frames based on their VLAN ID.**
2. **PCP - 3 priority bits that enables up to 8 differentiated QOS classed of service. PCP bits are part of the L2 VLAN header.**
3. **DSCP – 6 bits, part of the DS field in L3 IP header of incoming packets. The user configurable QOS scheme of EH-500TX enables allocating each of the potential 64 traffic classes, into the 8 queues of the system. EH-500TX support DSCP classification according to IPv4 and IPv6 L3 packets.**

4. MPLS Traffic Class (TC, formerly EXP) - 3 priority bits that enables up to 8 differentiated classes of service. The 3 TC bits are part of the MPLS label.

EH-500TX supports 4 types of bandwidth profile with CIR (committed information rate), CBS (committed burst size), EIR (excess information rate), EBS (excess burst size), can be assigned to each of the above listed (1-4) differentiated streams.

The implemented mechanism supports 3 colors and 2 rates:

- Frames that fit into CIR/CBS profile marked drop ineligible and colored “green”.
- Frames which are within excess profile but exceed committed profile are marked drop eligible (“yellow”), upon congestion at egress interface the yellow packets are dropped first.
- All remaining frames, which are out of profile, are colored “red” and discarded.
 - The “red” frames are dropped; “green” frames take precedence over “yellow” ones.

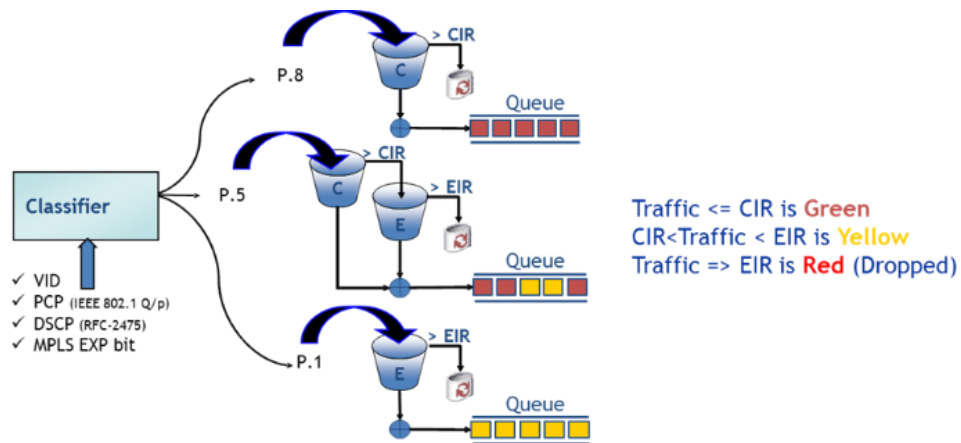

Figure 11 – EH-500TX Calculations and Policing

These packets are then mapped to 1 of the 8 priority queues (per interface). Each queue may be assigned buffering space (queue depth) manually or automatically by the SW that calculates the adaptive modulation BW changes. These queues are accessed by the scheduling mechanism.

4.2.2 Buffer size

Packets processed in the switch are held in buffers. If the destination queue is congested, the switch holds on to the packet as it waits for capacity to become available on the loaded queue. The ratio between delay and number of dropped frames is a result of the buffer size configuration.

4.2.3 Scheduling Mechanisms

The priority queues of the EtherHaul™ are accessed using the following scheduling mechanisms:

- **Strict Priority (SP):** Advanced mechanism for assuring both prioritization and minimal delay for mission critical traffic. Higher priority traffic is fully served through its differentiated queues, only if all high priority traffic, identified as SP, is fully served the lower priority traffic is delivered to its queues.
- **Weighted Fair Queuing (WFQ):** A scheduling technique maintaining fairness by applying weights to the queues. Each queue is serviced in the order of its weighted proportion to the available resources. This queueing mechanism is suitable for high capacity statistical applications and it ensures pre-defined serving of multiple services even when the link is fully loaded.
- **Shaper:** used to control traffic flows in order to optimize or guarantee performance and improve latency by limiting the maximum bandwidth of certain flows to maintain fairness and to assure SLA. Shaper capabilities of internet serving access devices, is crucial for assuring effective and stable delivery of TCP oriented traffic with minimizing re-transmissions and maximizing utilization of the available capacity.
- **Best Effort:** used for the lowest priority traffic types and simply enable further utilization of statistical multiplexing. Capacity is not guaranteed for this queue, and it enables dynamic utilization of all non-used (by higher queues) available capacity.

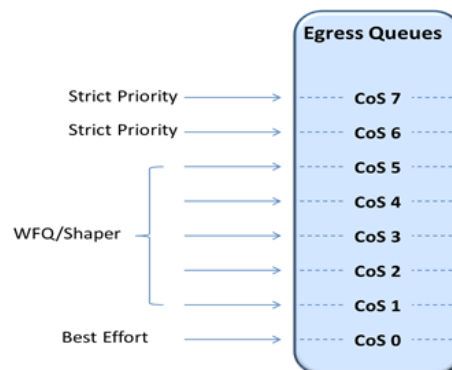

Figure 12 –Scheduling Mechanism

4.2.4 Standard compliance

- IEEE 802.1Q / IEE802.1P - 3 bits identified as priority code point (PCP).

- RFC-2475 - Architecture for differentiated services.
- RFC-5865 - A differentiated services code point (DSCP) for capacity-admitted traffic
- Related Metro Ethernet Forum (MEF) recommendations:
 - MEF 14, Ethernet Service Performance
 - Service performance, bandwidth profiles, BW profile rate enforcement.

4.2.5 Benefits

- Quality of Service (QoS) mechanism enables service providers to offer different classes of service for different types of traffic or customers.
- QoS mechanism is especially important in wireless links with adaptive capabilities, because changing link conditions may require the system to drop some traffic according to a predetermined priority and scheduling scheme.
- The user defined, wide range of buffer size values, enable fine adjustments for various implementation scenarios, and thus contribute to operators' network capability to optimize traffic flows at heavy load conditions.
- The statistical behavior of today data services enables service providers to oversubscribe their networks while differentiating services based on QoS driven SLA, and thus leads to faster ROI and improved utilization of the network.

4.3 Queue management - WRED

WRED function (Weighted random early detection) adds queue management mechanism to the EH-500T. Weighted Random Early Detection (WRED) is a queue management algorithm with congestion avoidance capabilities. A single queue may have several different queue thresholds. Each queue threshold is associated to a particular traffic class; a queue may have lower thresholds for lower priority packet.

WRED enables the EH-500TX to detect the onset of congestion and takes corrective action. EH-500TX has several different queue thresholds. Each queue threshold is associated to a particular traffic class.

A queue buildup will cause the lower priority packets to be dropped, hence protecting the higher priority packets in the same queue. In this way quality of service prioritization

is made possible for important packets from a pool of packets using the same buffer a standard traffic will be dropped instead of higher prioritized traffic.

4.3.1 WRED Benefits

- WRED assures that the queue does not fill up, so that there will be most of the time room for high-priority packets within the same queue.
- Random drops cause TCP sessions to reduce window sizes and thus extends efficiency.
- Average capacity usage is much closer to actual capacity of the link.

4.4 LAG / LACP

Link Aggregation Group (LAG) enables grouping a set of physical interfaces into a single service. Grouping a set of physical interfaces allows delivering a service at the combined aggregated throughput of all the grouped physical interfaces.

The Link Aggregation Control Protocol (LACP) is the protocol used between end-points to exchange system and port information and to maintain LAG services.

LAG/LACP enables the EH-500TX to deliver a service over 1Gbps and up to 2Gbps, utilizing very common 1Gbps copper or fiber ports.

4.4.1 Standard compliance

- IEEE 802.1ad - Link Aggregation Control Protocol (LACP)

4.4.2 Benefits

- Delivery of a service between 1Gbps and 2Gbps
- Standard based port aggregation
- Efficient utilization of the 500TX 2Gbps full-duplex bandwidth

4.5 Configurable Ethertype

IEEE 802.1ad Provider Bridging (a.k.a Q-in-Q) defines the Ethertype as 0x88A8 and lists additional Ethertype field values for S-VLAN: 0x8100, 0x9100 and 0x9200 to support backwards compatibility.

4.5.1 Benefits

The configurable Ethertype feature eliminates Ethertype compatibility issues when connecting EtherHaul™ ports/services to 3rd party switches and routers or other network

devices such as access points, small-cells etc. It is another tool for easy integration of EtherHaul™ into any network.

4.6 LLDP

The Link Layer Discovery Protocol (LLDP) is a unidirectional neighbor discovery protocol.

LLDP performs periodic transmissions of an ODU's capabilities to the adjacent connected stations. LLDP frames are not forwarded, but are constrained to a single link. The information distributed by the protocol is stored in a topology data base. This information can be retrieved by the user or network element using CLI and/or system's web based GUI, in order to easily resolve the network's physical topology and its associated stations.

LLDP enables the discovery of accurate physical network topologies, meaning which devices are neighbors and through which ports they connect. The user can use this information, especially the 'retrieved management IP addresses' option, in order to access these discovered nodes.

LLDP enables the EH-500TX to discover other network elements that are connected to it as well as being discovered. This feature enables, amongst other things, to discovery third-party network elements connected to the EH-500TX so that they can be managed. In addition, it enables easier integration of EH-500TX links in a LLDP supported network.

4.6.1 Standard compliance

- IEEE 802.1AB - Link Layer Discovery Protocol (LLDP)

4.6.2 Benefits

- Enhances troubleshooting process
- Standard based topology discovery by 3rd party network monitoring and management systems

4.7 Iperf

The built-in Iperf tester implementation includes client/server nodes for over the air TCP/UDP test. Configure one side as Server and run it (click Start) and remote end as Client (and enter the server IP address).

Iperf test run in parallel to traffic over the link.

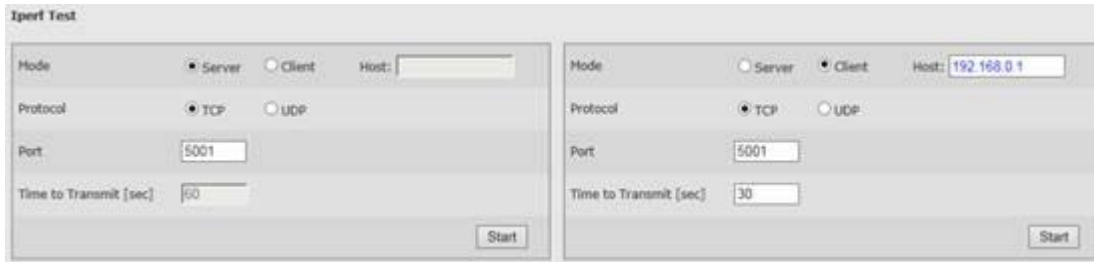

4.7.1 Benefits

Running Iperf helps the installer to make sure the link is installed properly without the need for external tools. More importantly, Iperf onboard support troubleshooting network and packet losses issues to identify connectivity problems much faster, without the need for on-site visits.

4.8 DHCP

The Dynamic Host Configuration Protocol (DHCP) is a computer networking protocol used by devices (DHCP clients) to obtain configuration information for operation in an Internet Protocol network. DHCP is built on a client-server model, where designated DHCP server allocates network addresses and delivers configuration parameters to dynamically configured hosts. "Client" refers to a host requesting initialization parameters from a DHCP server.

The EH-500T's management Interface can be configured as a DHCP client.

4.8.1 Standard compliance

- RFC 2131 - Dynamic Host Configuration Protocol

4.8.2 Benefits

- This protocol reduces system administration workload, allowing networks to add devices with little or no manual intervention.
- Easy and fast discovery of new EH-500TX elements added to any DHCP enabled network

4.9 Link OAM

Link OAM, as defined in IEEE802.3ah, is an Ethernet layer operation, administration, and management (OAM) protocol designed to ease monitoring and troubleshooting of networks. Link OAM enables to detect, verify, and isolate connectivity failures in

point-to-point connections. Link OAM is intended for single point-to-point links, usually used at network edges, between network-termination (NT) device located at customer premises and the directly connected to it, service provider's located access/aggregation network element.

The following IEEE802.3ah functionality is supported by the EH-500T:

- **Discovery:**
 1. Detect remote element
 2. Exchange link state and configuration information:
 3. Enable OAM on link
- **Remote Loopback**
 - Initiated by a loopback control OAMPDU
 - The loopback command is acknowledged by responding with an Information OAMPDU with the loopback state indicated in the state field.
 - The periodic exchange of OAMPDUs must continue while in the loopback state to maintain the OAM session.

4.9.1 Standard compliance

- IEEE802.3ah: EFM - Ethernet in the first mile

4.9.2 Benefits

- Standardized mechanism to monitor the health of a link and perform diagnostics
- Remote loopback enables standard based test equipment, to be connected at a central location in the network and perform service performance tests all the way to the network edge where the EH500TX unit is usually located.
- Reduces the probability for truck-rolls

4.10 Connectivity Fault Management (CFM)

Connectivity Fault Management (CFM) is an Ethernet layer operation, administration, and management (OAM) protocol designed to monitor and troubleshoot networks. CFM enables to detect, verify, and isolate connectivity failures in virtual bridged local area networks. A Maintenance Domain (MD) is a part of a network that is controlled by a

single operator and used to support the connectivity between service access points. There are eight hierarchical Maintenance Domain Levels (MD Level). Each CFM layer supports OAM capabilities independently, with the customer at the highest level, the provider in the middle, and the operator at the lowest level.

CFM is designed to be transparent to the customer data transported by the network and to provide maximum fault coverage. These capabilities enable easier commissioning and troubleshooting at networks operated by multiple independent organizations, each with restricted management access to each other's equipment. CFM entities support an individual service instance as Maintenance Association End Points (MEPs) are configured to create a Maintenance Association (MA). The MA monitors connectivity provided by that instance through the Maintenance Domain. Maintenance Association Intermediate Points (MIPs) are the intermediate points in a specific MA or MD.

The major features of CFM are fault detection, path discovery, fault verification, fault isolation, and fault recovery.

The system allows to:

- Define Maintenance Domain (MD)
- Define Maintenance Association (MA)
- Define Maintenance Association End Points (MEPs) and Maintenance Association Intermediate Points (MIPs)

The system supports the following monitoring tools:

- CFM Continuity Check Message (CCM)
- CFM Linktrace
- CFM Loopback

EtherHaul-500TX Product Description

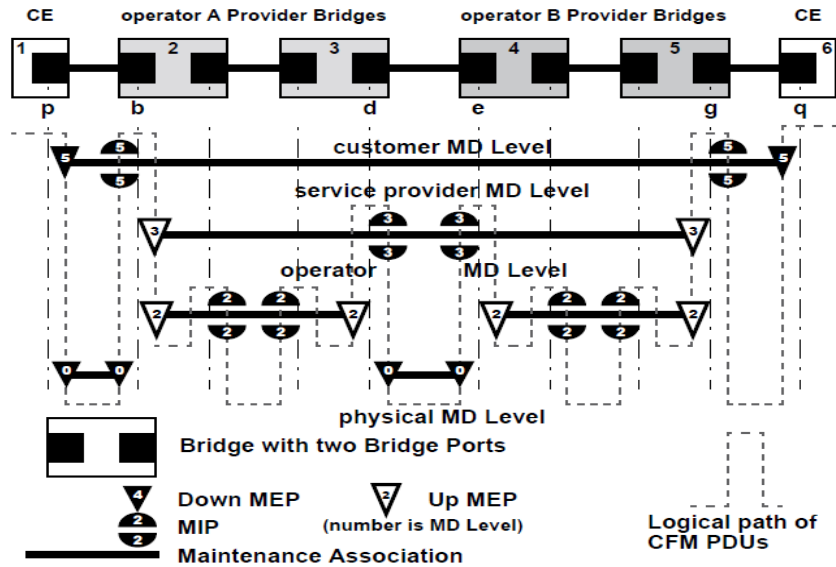

- UP MEP – transmit CFM PDUs into the bridge
- Down MEP – transmit CFM PDUs out of the bridge

Figure 13 – Typical CFM network

CFM allows the operator or service provider perform the following actions:

- Fault detection
- Path discovery
- Fault verification
- Fault isolation
- Fault recovery

4.10.1 Standard compliance

- IEEE 802.1ag: CFM - Connectivity Fault Management

4.10.2 Benefits

- End-end Monitoring of services
- Detection of faults before they are noticed or reported by the user
- Faster faults location isolation
- Enhances SLA assurance
- When used to monitor services across multi-networks, enables hiding internal topologies and network elements.

- Running in parallel to service traffic, in same paths, with no interfering the user traffic.

4.11 Performance monitoring OAM

Performance monitoring provides monitoring functionality according to Y.1731 standard. The following measurements are supported:

- Frame delay measurements
- Frame jitter measurements
- Frame loss measurements

4.11.1 Standard compliance

- ITU-T Y.1731 OAM functions and mechanisms for Ethernet based networks
- EH-500TX OAM functionality also complies with MEF 21, UNI Type 2 – Link OAM:
 - OAM Discovery process.
 - OAM PDU tests.
 - OAM TLV tests

4.11.2 Benefits

- Allows operators or service providers to monitor network performance and commit to SLA to the customer.
- Useful both for in-service monitoring and during faults troubleshooting

4.12 ITU-T G.8032 Ethernet Ring Protection (Resiliency)

Ethernet Ring Protection (ERP) is a network resiliency protocol defined by ITU-T G.8032. ERP functionality enables ultra-fast protection for any point of failure in a ring-topology network. This means that network connectivity is maintained in the event that the Ethernet link, the radio link, or even an entire EH-500Tlink fails in the ring. This provides resiliency for both Ethernet-physical rings that typically protect single site connectivity and Ethernet-RF rings that typically protect against RF network failure.

ERP is a relatively simple protocol that operates at the network level on the set of nodes that constitute the ring or set of rings. ERP monitors the Ethernet layer to discover and identify Signal Failure (SF) conditions, and prevents loops within the ring by blocking one of the links (either a pre-determined link or a failed link). ERP verifies at all times the

ring is closed that frames will not be looped. This is accomplished by taking down a Ring protection Link (RPL) whenever there is no failure in the ring.

EH-500TX supports ERP G.8032v2, with backwards compatibility to previous versions. Using ERP, the EH-500TX provides protection and recovery switching within 50 ms for typical rings. The ERP mechanism occupies extremely low portion from the available bandwidth.

Figure 14 illustrates the basic ERP protection mechanism. In normal ring operation, the RPL is blocked, between nodes C and D. In a failure condition, the failed link, between A & F, is blocked and R-APS(SF) messages are sent from the nodes adjacent to the failed links in order to unblock the RPL. An FDB flush is performed on all ring nodes as necessary.

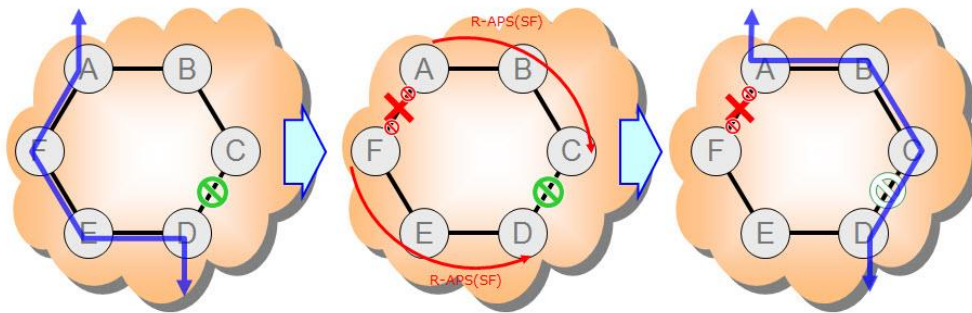

Figure 14 – Basic ERP Protection Mechanism

Among the ERP features supported by EH-500TX are:

- Backwards compatibility to previous versions
- Revertive and non-revertive behavior
- Flush logic with the Node-ID and BPR (Blocked Port Reference) mechanism
- Administrative commands (manual and forced switch, clear)
- Ability to block RPL at both ends of the link (RPL owner and RPL neighbor)
- Multiple logical ERP instances over a given physical ring

4.12.1 Standard compliance

- IEEE G.8032v2 Ethernet Ring Protection Switching

4.12.2 Benefits

- Non-proprietary protection resiliency standard that allows mixed-vendor deployments

EtherHaul-500TX Product Description

- **Carrier-class reliability, with sub-50ms performance**
- **Can be deployed in both all wireless backhaul environment as well as in mixed wireless / optical**
- **Overcomes old spanning-tree protocols issues while adding the faster restoration performance**

4.13 Ethernet Synchronization

4.13.1 Synchronous Ethernet (ITU-T G.8261)

EH-500TX supports Synchronous Ethernet (SyncE). The EH-500TX supports Synchronized Ethernet link input from the network side through one of the physical ports or from the radio side and providing a synchronized Ethernet link over the air to the other end of the wireless link within the required masks.

SyncE is a link-by-link timing distribution scheme that uses the Ethernet physical layer to accurately distribute clock frequency. ITU-T standard G.8261 defines various aspects of SyncE, such as the acceptable limits of jitter and wander as well as the minimum requirements for synchronization of network elements.

With SyncE, the receive clock is extracted from the Ethernet Rx by the clock unit and used for transmission on all interfaces, propagating the clock in the path. Every SyncE Network Element contains an internal clock called the Ethernet Equipment Clock (EEC). The EEC locks on the Rx clock and distributes it for transmission on all interfaces, attenuating jitter and wander, and maintaining clock-in holdover. If the Rx clock fails, the local unit switches to holdover and regenerates the clock accurately until the failure is corrected.

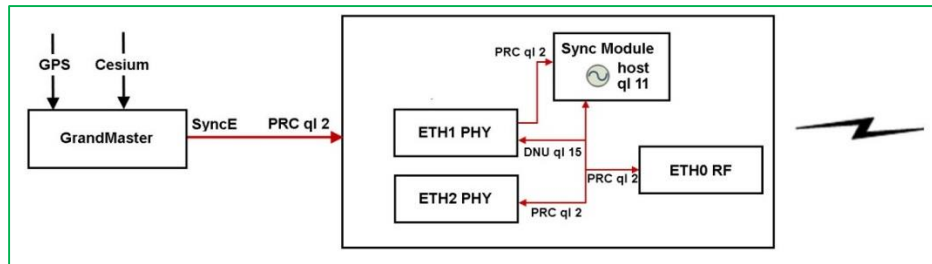

Figure 15 – EtherHaul™ ODU SyncE Functional Diagram

Synchronization messages are transported between the SyncE elements using Ethernet Synchronization Message Channel (ESMC). ESMC is similar to SSM (Synchronization Status Message), used in Sonnet/SDH systems. ESMC carries information about the Quality Level (ql) and sync status of the source clock, enabling EtherHaul™ products to determine which clock source to use, based on performance and the need to avoid loops. Quality Level is based on the clock's holdover performance.

4.13.1.1 Standard compliance

G.8261 defines various aspects of Synchronous Ethernet such as the acceptable limits of jitter and wander for packet networks as well as the minimum requirements for the synchronization function of network elements.

G.8262, Timing characteristics of Synchronous Equipment Slave Clock (EEC), defining the SyncE clock specs, such as Jitter, Wander, Holdover...

G.8264, Distribution of timing through packet networks, defining the Ethernet Synchronization Messaging Channel (ESMC) protocol

4.13.1.2 Benefits

SyncE allows operators and service providers a faster and reliable migration from legacy SDH/PDH/SONET networks to packet switched networks and thus significantly reduce OPEX.

Together with support of IEEE 1588, EtherHaul™ provide carrier class timing to remote sites and cell-sites, avoiding the need to deploy cumbersome GPS-based timing.

4.13.2 1588 Transparent Clock

Siklu's EH-500TX supports IEEE 1588v2 Transparent Clock (TC). The EH-500TX products comply with the mobile backhaul specifications for packet synchronization distribution.

1588v2 Transparent Clocks (TCs) used to overcome the 1588 synchronization performance issue due to packet delay variation over the network. In a wireless links, the compensation of the PDV needs to be done for the entire link including the air interface, and not only per node. Time stamping and the correction field update are HW based in EH-500T.

4.13.2.1 Standard compliance

- IEEE 1588v.2 - Precision Time Protocol (PTP)

4.13.2.2 Benefits

- Allows accurate “Wall time” synchronization in the packet switched network.
- Enables stamping updates

4.13.3 1588 optimization

The EtherHaul™ products provide optimized transport of the IEEE 1588v.2 packets allowing the slave to regenerate the clock within the required masks.

The IEEE standard 1588-2008, also known as 1588v2, defines a packet-based, timestamp distribution between a master clock and a slave, whereby the timing information originates from a Grandmaster clock function that is usually traceable to a Primary Reference Clock (PRC) or Coordinated Universal Time (UTC).

4.13.3.1 Standard compliance

- IEEE 1588v.2

4.13.3.2 Benefits

Allow accurate “Wall time” synchronization in the packet switched network.

5. Management concept

The EH-500TX is capable of delivering services out of the box, without any user configuration input. In this mode, the system acts as a fully transparent bridge, which matches many network configuration and it is intended for fast and easy service activation process.

For managed operations, the EH-500TX includes all fundamentals that enable easy configuration, monitoring, and troubleshooting, by variety of all leading Telco-grade systems, as well as direct local and remote management directly from operator’s desktop.

The supported management options are:

CLI	Professional Command Line Interface for full configuration and maintenance activities, with multiple privileges levels as required by service providers.
WEB GUI	Easy to interact user-interface via standard web-browser to manage both ends of the link, from one graphical screen.
RADIUS and TACACS+	RADIUS (Remote Authentication Dial-In User Service) and TACACS+ (Terminal Access Controller Access-Control System) are advanced authentication and report standards for large scale networks.

SNMP	Both versions 2 and 3 of the Simple Network Management Protocol are supported for north-bound connectivity to central configuration and monitoring systems.
FTP SFTP TFTP	FTP, TFTP and SFTP protocols designed to provide file transfer and other manipulations. The EH-500TX uses SFTP/FTP/TFTP for software upgrades, configuration uploads and downloads
SikluView	EMS – Elements Management System. Siklu solution for high level centralized administration and monitoring of EtherHaul™ elements and links

5.1 CLI

All EH-500T's functionality is accessible via secured command line interface (SSH). The user type defines the user's access privileges.

User	Read-only access, but cannot view user names, passwords, and other security settings.
Tech	Basic technical operations: can clear statistics, alarms, and log lists, and run diagnostics, but read-only access to configuration settings.
Super	Advanced operations and complete access to configuration options, but no access to user names, passwords, and other security settings.
Admin	Full access to all management and operations parameters.

5.1.1 Benefits

- Well know professional configuration and troubleshooting tool.
- Enables efficient, large scale projects rollouts with an easy loading of configurations scripts.
- Systems logs are easily reviewed and uploaded.
- Intuitive events' investigations and troubleshooting.

5.2 Web GUI

EH-500TX Units' and link functionality are accessible via secured HTML based Web interface (HTTPS), for monitoring, configuring, SW upgrades and diagnostic.

The GUI enables an easy, realistic view and operation:

- One screen manages both ends of the link
- 'Quick Configuration' wizard to help fast, easy and reliable installation by non-experts staff
- Link status is presented
- Ports highlighted according to actual status
- Real reflection of systems LED indicators
- When mouse pointer touches each topic in the menu, it automatically show list of available functions with no need to enter the other screen
- Link configuration and settings

5.2.1 GUI main screen

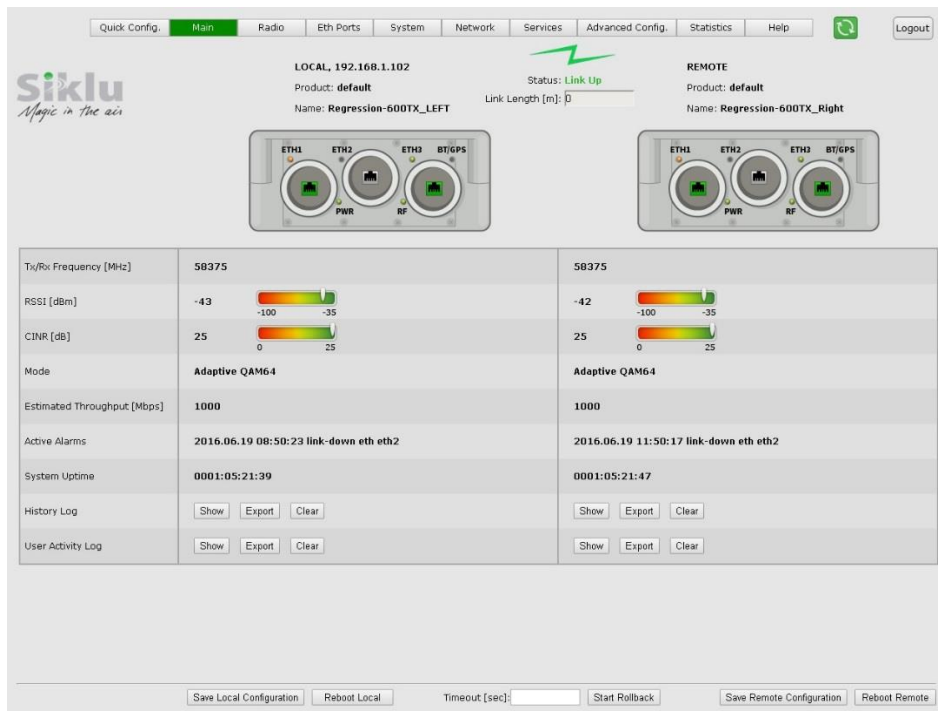

Figure 16: EH-500TX GUI main screen display

EtherHaul-500TX Product Description

The main screen (Figure 16) displays all essential link status information to enable easy and fast overview:

- Link status (up/down)
- Actual link length, automatically calculated by EtherHaul™ from the measured wireless delay between both ends of the link
- Used Ethernet ports
- RSSI and CNIR
- Current modulation level
- Available capacity
- Active events or alarms summary
- Shortcuts to both system log and user activity log

5.2.2 Quick configuration wizard

Easy, fast, and minimal configuration process enables one quick flow, for the user to set up a link with all mandatory parameters that leads to a fully managed mode of operation.

The quick configuration wizard includes 4 steps:

1. Configuration of system parameters:

- Specific system identification for the related location/service.
- Date and time (there is also an option for redundant central NTP connection).

The screenshot shows the 'Quick Config.' wizard interface. At the top, there is a navigation bar with tabs: 'Quick Config.', 'Main', 'Radio', 'Eth Ports', 'System', 'Network', 'Services', 'Advanced Config.', 'Statistics', and 'Help'. Below this, the interface displays 'LOCAL, 192.168.0.1' and 'Name: EH-600T' on the left, a lightning bolt icon with 'Status: Link Up' in the center, and 'REMOTE Name: EH-600T' on the right. The main configuration area is divided into two columns. The left column has a vertical sidebar with four steps: 'step 1 System' (highlighted), 'step 2 Radio', 'step 3 Eth Ports', and 'step 4 Network'. The right column contains 'Product Name' (Site_A), 'Date & Time' (Date: 2014.08.21, Time: 18:38:15), and a 'Next' button.

Figure 17: GUI managed mode wizard step 1

2. Configuration of the Radio:

- Frequency channel selection
- Tx power
- Maximum allowed modulation
- Symmetric / asymmetric mode selection

EtherHaul-500TX Product Description

The screenshot displays a configuration interface for the EtherHaul-500TX device. On the left, a vertical sidebar shows four steps: 'System' (checked), 'Radio', 'Eth Ports', and 'Network'. The main area is divided into two columns of settings:

Parameter	Left Column Value	Right Column Value
Channel Bandwidth [MHz]	500	500
Tx Frequency [MHz]	56375	56375
Rx Frequency [MHz]	0	0
Tx Power [dBm]	5	5
Alignment Status	Inactive	Inactive
Mode	QAM64 4 1 0.5	QAM64 4 1 0.5
Transmit Asymmetry	50TX-50RX	50TX-50RX

At the bottom of the interface, there are 'Back' and 'Next' buttons.

3. Management IP address

- Up to 4 concurrent addresses are supported
- Both IPv4 and IPv6 addresses are supported.

4. SNMP connectivity parameters

5.2.3 Standard compliance

- RFC2616 - Hypertext Transfer Protocol (HTTP)
- RFC2246 - Transport Layer Security (TLS) protocol
- RFC2818 - HTTP Over TLS

5.2.4 Benefits

- Configuration to an EH-500TX link is made in a simple, fast, and in a secured manner.
- No need for dedicated client or plugins in user's terminal.
- Multiple supported management addresses enable multiple network domains connections, eliminating the need for dedicated router/VPN for multi domains connectivity.

5.3 SNMP

The system supports SNMP v.2 and SNMP v.3 – for configuration, monitoring and northbound. EH-500TX support SNMP over both IPv4 and IPv6 L3 addresses schemes.

5.3.1 Standard compliance

- SNMP v.2
- SNMP v.3

SNMP is defined by the Internet Engineering Task Force (IETF).

5.3.2 Benefits

- Allows simple and standard integration into network management system.
- Enables monitoring, configuring and alarms flows to/from single or multiple north-bound systems.
- Most of the SNMP objects (sub element for control / monitor) are well defined by the IETF standard, thus time to market with most of systems' parameters can be within hours.

5.4 FTP/SFTP/TFTP

FTP, TFTP and SFTP are network protocols designed to provide file transfer and file manipulation facilities, with optional security services. The EH-500TX uses SFTP/FTP/TFTP for software upgrades, configuration uploads and downloads.

5.4.1 Standard compliance

RFC4251- The IETF extension, of the Secure Shell protocol (SSH) version 2.0.

5.4.2 Benefits

EH-500TX maintenance activities are performed in a secured and standard based method, with standard IT tools.

5.5 User management

The EH-500TX supports both local user management as well as centralized management with industry standard Radius or TACACS server.

5.5.1 Local/Remote user management

The user type defines the user's access privileges.

User	Read-only access, but cannot view user names, passwords, and other security settings.
Tech	Basic technical operations: can clear statistics, alarms, and log lists, and run diagnostics, but read-only access to configuration settings.
Super	Advanced operations and complete access to configuration options, but no access to user names, passwords, and other security settings.
Admin	Full access to all management and operations parameters.

5.5.2 Radius and TACACS+ user management

RADIUS (Remote Authentication Dial-In User Service) and TACACS+ (Terminal Access Controller Access-Control System) are 2 industry standard for Authentication, Authorization and Accounting (AAA):

- **Authentication:** Identification of requester profile (username, password, and privilege level) on a per-request basis.
- **Authorization:** Permission/denial of access to a subset of commands subject to authentication success/failure. (The mechanisms of Authorization and authentication are independent of each other.)
- **Accounting:** Reporting of information on requesters (identities, number of access attempts per requester, start, and stop times, executed commands, etc.)

The EH-500TX is a Network Access Server (NAS) for requesters and functions as AAA client passing requester information (e.g. username, password, etc.). The AAA Server is responsible for receiving connection requests, authenticating or disqualifying the

requester, and sending the permit or denies response to the client EH-500T. Communication between the EH-500TX and the AAA Server is performed by shared secrets which are never sent over the network. In addition, every administrator password is encrypted before it is sent between the EH-500TX and the AAA Server in order to prevent deciphering.

The AAA Server can also provide accounting of requester commands and of changes in authorization level. This information is recorded in a special log file that enables a supervisor to view the activities of all the administrators. Accounting can include logging of commands or logging of transitions from one mode to another.

The EH-500TX supports user authentication with TACACS+ or Radius AAA servers, up to five servers.

5.5.3 Benefits

- The hierarchical 4 levels user's access privileges suits all network sizes: large network operators, carrier-of-carrier providers as well as smaller local operators and WISPs. It enables clear separation between multiple classes of users.
- The RADIUS and TACACS supports, adds centralized user and rights management for large network operators, carrier-of-carrier providers by enabling connectivity control and accounting to minimize IT interactions with end-users without compromising security aspects.

6. Security

6.1 Security features description

- Physical
 - Pencil beam – requires a physical location within antenna transmission path.
 - Minimal reflections. Both the extremely low transmit power and ultra-high frequencies contribute to minimal reflections effects and thus enhances system's resiliency and noticeable footprint.
 - Proprietary DSP (Digital Signal Processor) for RF signals requires Siklu ODU to intercept.

- Synchronized transmission – only ‘man-in-the-middle’ interception for eavesdropping.
- Link / data encryption
 - Link ID – link layer password
 - AES with 128/256 bit security (licensed based)
- Management aspects
 - SNMPv3 - Supporting both HMAC (Hash-based message authentication code) and MD5 (message-digest algorithm)
 - Access list for Host (management access) - ACL based on IP and Mask for security and Denial of Service
 - Management VLAN for isolated control of the device
 - Secured communication protocols for management: SSH (Command Line Interface), HTTPS (Web-GUI), SFTP (SW download and File Transfer)
- User access
 - Different user types and privileges categories

6.2 Interface to external access rights management systems

The EH-500TX includes full Radius/TACACS+ AAA support:

- **Authentication:** Identification of requester profile [username, password, and privilege level] on a per-request basis.
- **Authorization:** Permission/denial of access to a subset of commands subject to authentication success/failure. (The mechanisms of Authorization and authentication are independent of each other.)
- **Accounting:** Reporting of information on requesters (identities, number of access attempts per requester, start and stop times, executed commands, etc.)

7. Logging and auditing features

Advanced logging and performance monitoring logs/stats are available and kept in the device. The information can also be exported and collected using File Transfer (both FTP, SFTP are supported).

Logs:

1. **Current alarms**
2. **Alarm & event log file (history)**
3. **User activity log (stores all actions and configuration commands)**

Performance statistics:

1. **RF link statistics: RSSI, CINR, Modulation changes, RF statistics (errors and frame loss counters)**
2. **Ethernet ports statistics**
3. **VLAN statistics**
4. **Queues statistics**

7.1 System alarms and events

The system displays active alarms using the Web EMS or the CLI.

The following table lists all System Alarms and Events, together with their severity, possible cause and corrective actions:

Indication	Classification and Severity	Explanation	Probable Cause	Corrective Actions
Cold Start	Event [Trap, Log]	The ODU is re-initializing due to a Power-Up or Reset action.	N/A	N/A
Link Down	Alarm High [Trap, Log, Active Alarm List]	The communication link (either the RF or one of the Ethernet ports) is not operational.	Ethernet:	Ethernet:

EtherHaul-500TX Product Description

Indication	Classification and Severity	Explanation	Probable Cause	Corrective Actions
			1) A cable is disconnected. 2) Configuration mismatch between the ODU and end-equipment. RF Link: 1) Configuration mismatch between sides (frequency, modulation, RF role, etc.) 2) Line-of-Sight disruption or antennas not aligned. 3) Faulty ODU	1) Check the cable connection. 2) Check the CLI configuration and end-equipment configuration. RF Link: 1) Check the configuration. 2) Isolate the problem using loopbacks. 3) Check cable connections and antenna alignment. 4) Replace ODU
Link Up	Event [Trap, Log]	The communication link (either the RF or one of the Ethernet ports) is operational.	N/A	N/A
Modulation Change	Event [Trap, Log]	The modulation setting for the RF link (currently in Adaptive mode) has changed.	N/A	N/A
Temperature High	Alarm Medium [Trap, Log, Active Alarm List]	The ODU temperature has exceeded a predefined threshold.	1) The ODU is installed in extreme temperature conditions. 2) Wrong temperature reading made in the ODU	1) Check the ODU installation and verify that it is installed in accordance with environmental specifications. 2) Replace ODU
Temperature Normal	Event [Trap, Log]	The temperature of the device has returned to the normal range. This event clears a Temperature High alarm.	N/A	N/A
SFP In	Event [Trap, Log]	SFP inserted	N/A	N/A
SFP Out	Event [Trap, Log]	SFP extracted	N/A	N/A

EtherHaul-500TX Product Description

Indication	Classification and Severity	Explanation	Probable Cause	Corrective Actions
Reference Clock Source Change	Event [Trap, Log]	The reference clock source for the EtherHaul system has changed.	N/A	N/A
CFM Fault Alarm	Alarm High [Trap, Log, Active Alarm List]	A maintenance endpoint (MEP) has a persistent defect condition.	Varies	1) Use the reported OID to determine the source of the fault.
CFM Fault Recovery	Event [Trap, Log]	All MEP defects have been cleared and the alarm has been cleared from the Active Alarm List.	N/A	N/A

EtherHaul-500TX Product Description

Indication	Classification and Severity	Explanation	Probable Cause	Corrective Actions
Synthesizer Locked	Event [Trap, Log]	The synthesizer has been locked.	N/A	N/A
Synthesizer Unlocked	Alarm High [Trap, Log, Active Alarm List]	The synthesizer has been unlocked.	N/A	N/A
POE Status Low	Alarm High [Trap, Log, Active Alarm List]	The power level being drawn by the ODU from the Ethernet is low.	Problematic PoE, ODU or connection	1) Check voltage and current supply to the PoE 2) Check cable 3) Replace PoE 4) Replace ODU
POE Status Normal	Event [Trap, Log]	The power level being drawn by the ODU from the Ethernet is normal.	N/A	N/A
ERP Ready	Event [Trap, Log]	ERP is ready for operation	N/A	N/A
Forced Switch	Event [Trap, Log]	ERP event	N/A	N/A
Manual Switch	Event [Trap, Log]	ERP event	N/A	N/A
Signal Fail	Event [Trap, Log]	ERP event	N/A	N/A
Invalid version	Event [Trap, Log]	ERP event	N/A	N/A
Loopback Enabled	Alarm Low [Trap, Log, Active Alarm List]	User enabled loopback	User action	N/A
Loopback Disabled	Event [Trap, Log]	Loopback cleared	User action	N/A
Tx Mute Enabled	Alarm Low [Trap, Log, Active Alarm List]	User enabled Tx Mute	User action	N/A
Tx Mute Disabled	Event [Trap, Log]	Tx Mute cleared	User action	N/A

EtherHaul-500TX Product Description

Indication	Classification and Severity	Explanation	Probable Cause	Corrective Actions
Reception of QL EEC1 or Worse	Alarm Low [Trap, Log, Active Alarm List]	SyncE quality received on the link is same or worse than the ODU's internal clock quality	Network changes or sync failure	N/A
Reception of QL better than EEC1	Event [Trap, Log]	SyncE quality restored	N/A	N/A

Table 7: System alarms and events

7.2 System statistics

The EH-500TX uses advanced RF and Ethernet counters to provide real-time performance statistics for radio transmission (RF) activities, Ethernet ports, VLAN traffic, and QoS queues.

The EH-500TX collects a full day of 15 minutes statistics (96 bins) and 30 days of 24 hours history summary, the counters are available for RF, per ETH port and per VLAN (service).

The following statistics enable quick analysis of system and component performance in support of troubleshooting and diagnostics:

RF	<p>Displays RF statistic counters to identify radio errors and check the radio status history. The RF statistics consist of real time statistic counters since the last time the counters were cleared</p> <p>Detailed collected statistics: in-octets, in-idle-octets, in-good-octets, in-errored-octets, out-octets, out-idle-octets, in-pkts, in-good-pkts, in-errored-pkts, in-lost-pkts, out-pkts, min-cinr, max-cinr, min-rssi, max-rssi, min-modulation, max-modulation</p>
VLAN	<p>Displays statistic counters of each EtherHaul™ link component per VLAN</p> <p>Detailed collected statistics: in-octets, in-ucast-pkts, in-discards, in-errors, out-octets, out-ucast-pkts, out-errors, in-mcast-pkts, in-bcast-pkts, out-mcast-pkts, out-bcast-pkts, out-discards, in-no-rule-discards</p>

<p>Ethernet Ports</p>	<p>Displays Ethernet statistics counters per Ethernet port</p> <p>Detailed collected statistics: in-pkts, out-pkts, drop-pkts</p>
------------------------------	--

7.2.1 Benefits

Real time and historical data, including RF, Ethernet ports, and VLANs values enable simple and reliable way to identify operating faults and monitor link's performance by both operators and automatic statistics collection systems.

7.2.2 Standard compliance

RFC2819 – RMON Remote Network MONitoring

7.3 System loopbacks

The EH-500TX provides Ethernet and RF loopbacks designed to enable fault isolation and Ethernet service performance testing. Loopbacks functions are user configurable and support timeout in seconds.

- **Ethernet Loopback** – Internal and external loopbacks are performed on the interface, testing the local ODU, the radio link, and the remote ODU.
- **RF (Radio) Loopback** – Internal loopback is performed on the ODU's RF output.

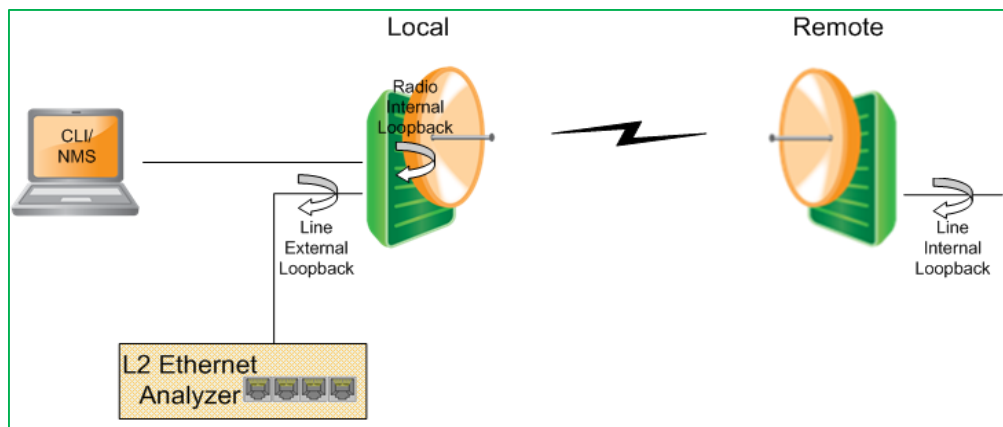

Figure 18 –System loopback points

System alarms as well as statistic displays should be used to determine if Loopback testing has passed or failed.

7.3.1 Benefits

- Enables end-to-end link tests or single unit self-test for fault detection and isolation.
- 5. Significantly reduces operation costs by saving truck-rolls as well as number of test equipment needed for network maintenance.

8. Power supply

8.1.1 DC power supply

EH-500T: PoE+ (IEEE 802.3at), 26W without PoE-Out; up to 78W with PoE-Out; alternatively, carrier-grade 48VDC (DC input range: 36 ÷ 57 VDC, flexible grounding).

8.1.2 Benefits

Due to the efficient system design and high integration into silicon, the EtherHaul-500T:

- Reduces the power consumption and accordingly the associated energy costs.
- Enables wide range of DC Voltage input

9. EtherHaul Deployment Topologies

The EtherHaul™ may be deployed in topologies such as:

- **Point-to-Point** - Two units are used to implement a point-to-point hop
- **Point-to-Multipoint** – A number of links is used to implement a number of parallel point-to-point hops, using a star topology. The ends of the link in the center point may be chained to each other, or be multiplexed using a simple Ethernet switch.
- **Daisy-chain** – A number of links is used to implement an open series of point-to-point hops, where traffic could be dropped and added at each node in the chain. Typically the nodes can be connected without an additional Ethernet switch.

EtherHaul-500TX Product Description

- **Ring** – A number of links is used to implement a closed series of point-to-point hops, where traffic could be dropped and added at each node in the ring. This topology enables a diversity of packet routing options.
- **Mesh** - A number of links is used to implement a series of point-to-point hops which enable interconnection between the nodes, where traffic could be dropped and added at each node in the mesh. This topology enables redundant interconnections between the nodes.

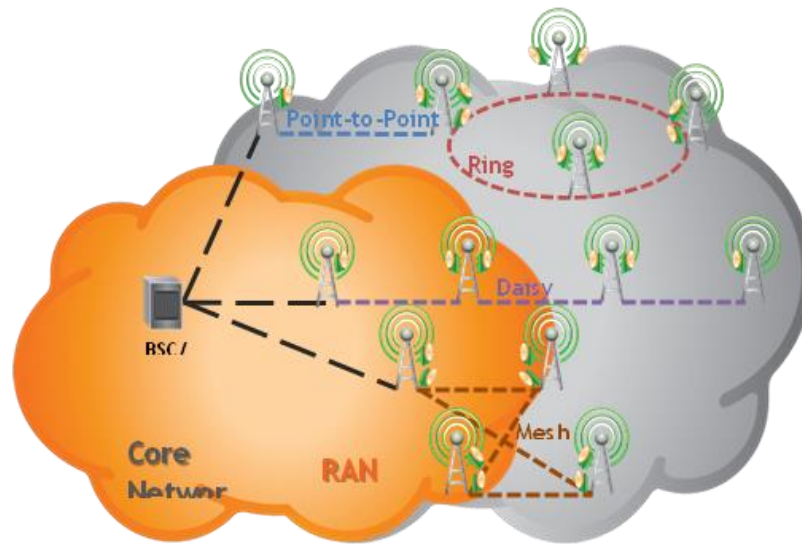

Figure 19 - Deployment topologies

In all the topologies the product performs packet forwarding based on L2, and QoS based on either L2 or L3 information. Thus each packet incoming from any port in the entire network can be identified at any other node in the network, typically according to its VLAN tag and CoS bits. Based on this identification, a node can assign the packet to the proper priority queue, and thus force it to share the BW in a controlled manner with packets coming from other sources. The bandwidth allocation policy (QoS) at each node is fully controlled from the management system.

9.1 Point to point

The preferred products for each installation can be matched based on the following criteria:

- **Installation outline: location, available space and frequency planning**
- **Distance**
- **Capacity**
- **Availability**
- **Price**

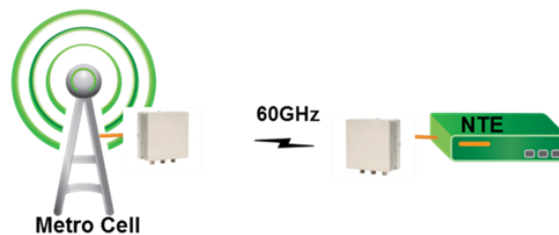

Figure 20 - EH-500TX point-to-point

9.2 Daisy Chain, Ring and Mesh topology connection

The scenarios for daisy chain, ring and mesh consist of back-to-back wireless links connecting between the sites. At each site the links are connected to each other without requiring an Ethernet switch, since each EtherHaul has three or four Ethernet ports (based on the product used). The back-to-back links at each site provide together at least 8 Ethernet ports, where typically one port will be used to connect the local BS, two ports will be used to connect the two links, and 3 ports is left free (may be used for local management). There is no need for external switch for supporting chains ring and mesh topologies, using EtherHaul products that contain a build in switch a one box solution is achieved with all the advantages of a L2 MEF complaint switch.

EtherHaul-500TX Product Description

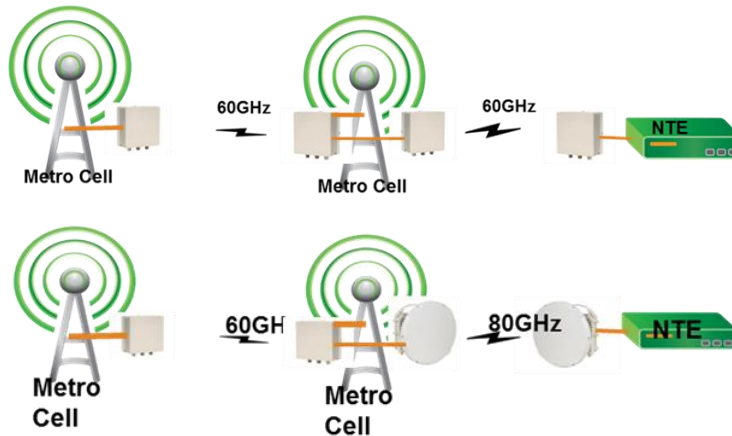

Figure 21 - EH-500TX Daisy chain

9.2.1 Solution benefits

- **Integrated, MEF compliant, switch with 3 GE interfaces, especially designed for daisy chain and still preserve the ability to connect “drop” more customers/services (Technology/ costumers co-location)**
- **Max installation flexibility - Any combination between the chained links**

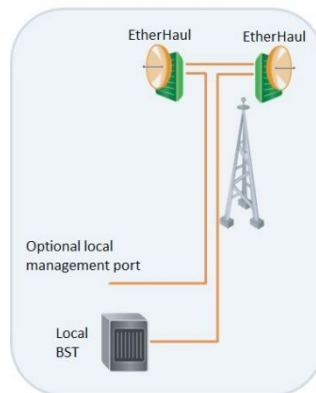

Figure 22 - Daisy chain, Ring and Mesh connection

10. List of supported standards by EtherHaul

- **IEEE 1588v2 TC**
- **Synchronous Ethernet ITU-T G.8261/8262/8264**
- **AES 128-bit and 256-bit**

EtherHaul-500TX Product Description

- **MEF 9,14 and 21 complaint**
- **Eth OAM (IEEE802.1ag/Y.1731/IEEE802.3ah)**
- **G.8032 ERPS**
- **VLAN/VLAN stacking (QinQ- IEEE 802.1ad Provider Bridge)**
- **IEEE 802.1d Transparent Bridging**
- **Traffic management - 802.1p (L2), DSCP (L3) & MPLS EXP (L2.5)**
- **Antennas: ETSI EN 302 217-4 Class2**
- **Ingress Protection Rating: IP67**
- **SNMP: v2/3**
- **Frequency Regulations:**
 - **ETSI EN 302 217-3**
 - **UK IR 2078 & IR 2000**
 - **USA FCC Part 15.255**
- **Transportation: EN 300 019-1-2 Class 2.2**
- **Storage: EN 300 019-1-1 Class 1.2**
- **Operation: EN 300 019-1-4 Class 4.1E**
- **Safety: UL 60950**
- **EMC: EN 301 489-4 ;FCC 47 CFR part 15**
- **CE: CE Marked**

About Siklu

Siklu delivers Gigabit capacity millimeter wave wireless backhaul solutions operating in the 60, 70 and 80 GHz bands. Ideal for dense, capacity-hungry urban security networks, the ultra-high capacity wireless links can be easily and discreetly installed on the very same street fixtures as the security cameras. The most deployed mmW radios in the world, thousands of units are delivering carrier grade performance in varying weather conditions around the world.

