



# Industrial Wireless

Wireless from the sensor to the network

# Our Industrial Wireless products for your automation infrastructure

Phoenix Contact is a leading international supplier for automation infrastructure. Industrial Wireless products from Phoenix Contact provide reliability and security for the transmission of data and signals.

Wireless systems allow you to easily and efficiently negotiate the many challenges faced in an industrial communication infrastructure.

## Your advantages

- ✓ Flexibility, easy installation, and cost savings compared to cable-based installations
- ✓ Bypassing of obstacles
- ✓ Alternative to slip rings that are prone to wear, and to cable lines on mobile devices
- ✓ Reduced maintenance costs
- ✓ Monitoring and control of remote stations without cable access



## Contents

---

Wireless technologies	4
-----------------------	---

---

Wireless I/O	
TC Mobile I/O for monitoring sensors via cellular communication	6
The Wireless MUX wireless signal cable	8
Radioline – easy signal distribution with I/O mapping	10
Radioline – I/O mapping now also available in wired format	12
Radioline extension modules	14

---

Wireless Serial	
Radioline for wireless networking of serial interfaces	16
Radioline – solutions for use in outdoor applications	18

---

Wireless Ethernet	
NearFi couplers	20
Bluetooth Low Energy	22
Industrial Bluetooth	24
Industrial WLAN	26
Cellular routers and remote maintenance gateways for worldwide network access	28

---

Product overview for antennas and accessories	30
---	----

---

Services	34
----------	----

---



# Wireless technologies

## Different wireless technologies for special industrial requirements

In industry, there is a vast range of applications for wireless technologies, from the transmission of a simple sensor value all the way to a powerful network with hundreds of devices. This means that the requirements for wireless technology differ significantly.

This broad range of requirements is not satisfied entirely by one single wireless technology. Phoenix Contact provides products and solutions for different license-free and free-of-charge wireless technologies which can cover virtually all industrial areas of application.

The key requirement for the use of wireless technologies in industrial applications is that the technology must be as robust and reliable as a cable connection, even under harsh conditions. With wireless communication, the data is transmitted with electromagnetic waves through free space that is not available exclusively. The wireless connection is therefore subjected to interference, such as electromagnetic interference fields, which can adversely affect transmission. In addition, reflections, fading, interference, and shadowing can occur. Despite the impacts described, the wireless systems work without interference.



Wireless technologies		
 NearFi Technology Designed by Phoenix Contact	 Bluetooth Low Energy	 Bluetooth
Range with line of sight		
<ul style="list-style-type: none"> <li>Up to 10 mm</li> </ul>	<ul style="list-style-type: none"> <li>Up to 200 m</li> </ul>	<ul style="list-style-type: none"> <li>Up to 250 m</li> </ul>
Description		
NearFi is a contactless real-time transmission technology for transmitting power and data across an air gap of up to 10 mm.	Bluetooth Low Energy enables energy-saving wireless communication with battery-operated sensors.	Bluetooth for the fast and efficient transmission of I/O and Ethernet data in machine building and systems manufacturing.
Fields of application		
<ul style="list-style-type: none"> <li>Wireless real-time Ethernet data and power</li> </ul>	<ul style="list-style-type: none"> <li>Wireless IO data and measured values</li> </ul>	<ul style="list-style-type: none"> <li>Wireless I/O: Analog and digital I/O signals</li> <li>Wireless Ethernet: Ethernet data</li> </ul>
Applications		
<ul style="list-style-type: none"> <li>Robots</li> <li>Material transport systems</li> <li>Automated guided vehicle systems</li> <li>Handling/lightweight robots</li> <li>Cleanroom systems</li> </ul>	<ul style="list-style-type: none"> <li>Integration of Bluetooth Low Energy sensor technology</li> <li>Battery-operated sensor technology</li> </ul>	<ul style="list-style-type: none"> <li>Replacement of cables for wireless PROFINET and PROFI-safe communication</li> <li>Replacement of signal lines</li> </ul>
From page 20	From page 22	From page 8, from page 24

## Industrial 5G – wireless networking for efficient processes

In the future, Industrial 5G will enable reliable, wireless networking with high data speeds, high numbers of participants, and extremely low latency times. It provides the foundation for scenarios of the future, including Industry 4.0 and the All Electric Society, in which comprehensive networking and smart factories are standard. 5G, the 5th generation of wireless broadband technology, allows users to establish reliable connectivity, which in turn allows flexible, autonomous, and efficient processes from production to logistics.



Industrial 5G – opportunities and capabilities of a new technology

<p style="text-align: center;"><b>WLAN WLAN AX WiFi 6</b></p>	<p style="text-align: center;"><b>TRUSTED WIRELESS™</b></p> 	<p style="text-align: center;">   <b>5G 4G 3G 2G</b> </p>
<ul style="list-style-type: none"> <li>• Up to 1 km</li> </ul>	<ul style="list-style-type: none"> <li>• Up to 32 km (900 MHz)</li> <li>• Up to 20 km (868 MHz)</li> <li>• Up to 5 km (2.4 GHz)</li> </ul>	<ul style="list-style-type: none"> <li>• Worldwide</li> </ul>
<p>WLAN is a wireless standard in accordance with IEEE 802.11 for establishing wireless local area networks.</p>	<p>Trusted Wireless was designed specifically for the reliable transmission of data and signals over ranges of up to several kilometers.</p>	<p>Communication is via private or public cellular networks. In public networks, the telecommunications providers provide the necessary infrastructure.</p>
<ul style="list-style-type: none"> <li>• Wireless Ethernet: Ethernet communication with moving and mobile devices</li> </ul>	<ul style="list-style-type: none"> <li>• Wireless I/O: Analog and digital I/O signals (modular extension possible)</li> <li>• Wireless Serial: Serial RS-232 and RS-485 data</li> </ul>	<ul style="list-style-type: none"> <li>• Wireless I/O: Analog and digital I/O signals</li> <li>• Wireless Ethernet: Ethernet data</li> </ul>
<ul style="list-style-type: none"> <li>• Autonomous mobile robots and Automated Guided Vehicles (AGVs)</li> <li>• PROFINET and PROFIsafe communication</li> </ul>	<ul style="list-style-type: none"> <li>• Connection of remote pump stations</li> <li>• Rotating parts (e.g., in scraper bridges)</li> <li>• Level monitoring on reservoirs</li> <li>• Pipeline monitoring</li> </ul>	<ul style="list-style-type: none"> <li>• Remote access to machines and systems</li> <li>• Monitoring signal states</li> </ul>
<p><b>From page 26</b></p>	<p><b>From page 10</b></p>	<p><b>From page 6, from page 28</b></p>

## Wireless I/O

# TC Mobile I/O for monitoring sensors via cellular communication

Monitor analog and digital values easily and securely via the cellular network and switch relays remotely. The TC Mobile I/O transmits your data via SMS, e-mail, or app (https, SMS). The broad voltage range and the various inputs means that the signaling system can be used in a wide range of applications.

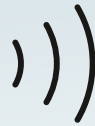

### Your advantages

- ✓ Future-proof with 4G cellular technology (LTE)
- ✓ Suitable for buildings and harsh industrial environments
- ✓ Monitoring of connected sensors (0/4 ... 20 mA)
- ✓ Monitoring of voltages up to 60 V
- ✓ Relay switching via cellular communication
- ✓ SMS alert in the event of power failure

# Product overview TC Mobile I/O



Cellular communication module, DC  
TC MOBILE I/O X200-4G

Order No. [1038567](#)

- 4G (LTE) SMS relay and remote signaling system, European version, communication via SMS or cellular communication data connection (e-mail transmission, app)
- 4 digital inputs, 4 relay outputs
  - 2 analog inputs (voltage or current)
  - Voltage range: 10 V DC ... 60 V DC
  - Compact design (4TE, DIN 43880)
  - Temperature range: -25°C ... 70°C
  - Easy configuration with conventional USB cable and web browser



Cellular communication module, AC  
TC MOBILE I/O X200-4G AC

Order No. [1038568](#)

- 4G (LTE) SMS relay and remote signaling system, European version, communication via SMS or cellular communication data connection (e-mail transmission, app)
- 4 digital inputs
  - 4 relay outputs
  - Voltage range: 93 V AC ... 250 V DC
  - Compact design (4TE, DIN 43880)
  - Temperature range: -25°C ... 70°C
  - Easy configuration with conventional USB cable and web browser

## TC Mobile I/O app

Switch your outputs conveniently using the app. This means that you can check the status of your device at any time. The TC Mobile I/O app makes it even easier to handle the text message version and saves you from having to write a text message. You will receive the alarm as usual via SMS and e-mail. This ensures the best accessibility in the field.



## Monitoring sensors via cellular communication

The TC Mobile I/O product family allows you to monitor analog current levels and analog voltage values and switch relays remotely. Communication is via SMS, e-mail, or app (https, SMS).

### Possible areas of application:

- Machine, building, and system monitoring
- Pumps, wastewater treatment plants, and water supply
- Lighting control systems and remote switching devices
- Street lighting
- Elevators and gates
- Alarm technology and building services
- HVAC technology
- Battery monitoring up to 60 V
- Railway applications in accordance with EN 50121-4

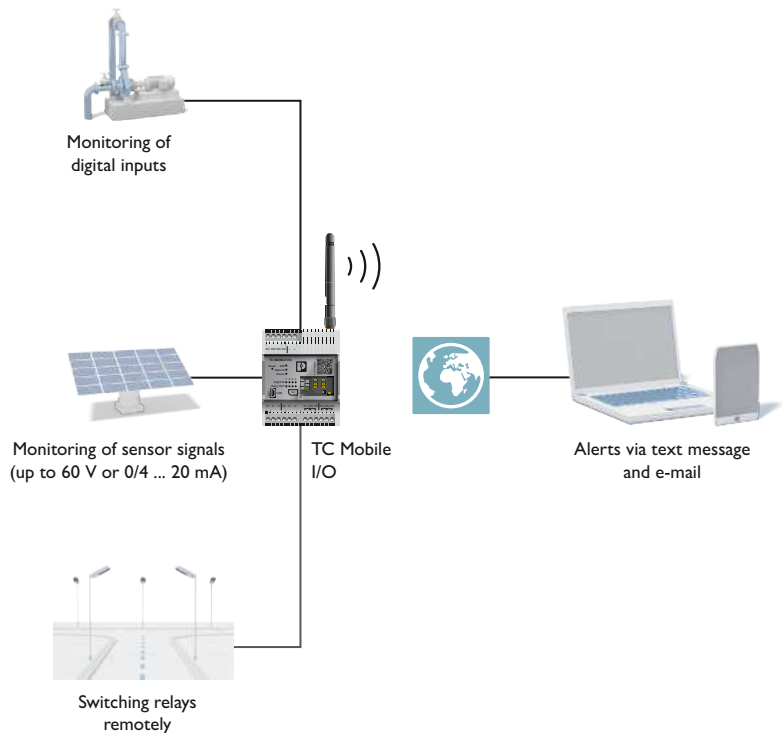

## Wireless I/O

# The Wireless MUX wireless signal cable

The wireless multiplexer transmits 16 digital and two analog signals bi-directionally, i.e., in both directions, which means that it can replace a 40-wire signal cable. Also, the connection is monitored continuously. If there is gross interference in the link or it is interrupted, the outputs are reset to the defined LOW state. This is indicated on the module by a diagnostic LED. The link quality display provides the user with constant information on the quality of the link.



### Your advantages

- ✓ Connections established and signals transmitted automatically based on fixed pairing
- ✓ No configuration or settings required
- ✓ Typical transmission time of less than 10 ms
- ✓ Extremely robust and reliable
- ✓ Interference-free operation alongside WLAN





# Product overview wireless sets



## Wireless set with antennas

ILB BT ADIO MUX-OMNI

Order No. [2884208](#)

- Standard package consisting of two permanently paired modules, two omnidirectional antennas with 1.5 m cable
- Ranges between 50 and 100 m in halls and over 200 m outdoors
- Antenna connection: RSMA (female)
- Approvals: FCC, UL 508, MIC (Japan)

## Wireless set without antennas

ILB BT ADIO MUX

Order No. [2702875](#)

- Package consisting of two permanently paired modules
- Ranges of over 400 m with directional antennas with a free line of sight
- Antenna connection: RSMA (female)
- Approvals: FCC, UL 508, MIC (Japan)

## Technical data for wireless sets:

- Current Bluetooth 4.0 technology
- Supply voltage: 19.2 V DC ... 30 V DC
- 16 digital inputs
- 16 digital outputs up to 500 mA
- 2 analog inputs/outputs 0 ... 20 mA or 0 ... 10 V

## Wireless MUX, the wireless signal cable

Connection to the controller is quick and easy using existing input and output channels.

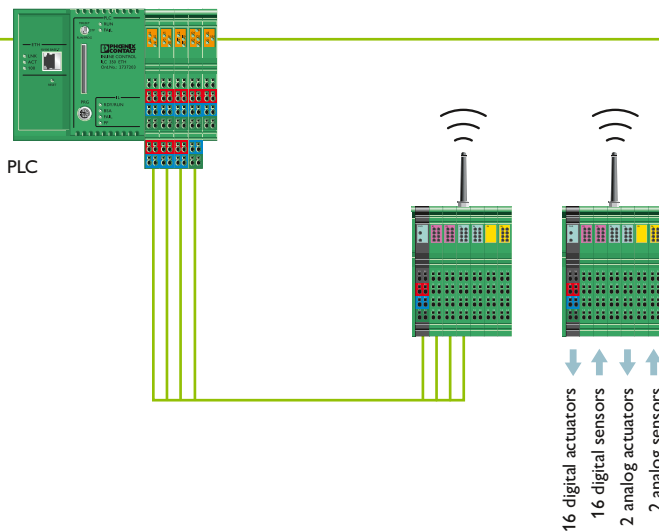

Ready to use: Unpack, connect, and switch on

## Possible areas of application

The Wireless MUX is used wherever a small number of digital or analog input and output signals need to be exchanged wirelessly with a remote or movable station. Factory automation in particular is characterized by machine parts that are constantly in motion.



Dynamic applications

## Wireless I/O

# Radioline – easy signal distribution with I/O mapping

Radioline is the wireless system for large systems and networks. Special features include extremely easy assignment of inputs and outputs by simply turning the thumbwheel – without any programming. Radioline transmits I/O signals as well as serial data, and is therefore very versatile. In addition, you can implement various network structures: From a simple point-to-point connection to complex networks.



**TRUSTED  
WIRELESS™**



### Your advantages

- ✓ Easy startup without programming
- ✓ One device for a wide range of applications
- ✓ Integrated RS-232 and RS-485 interface
- ✓ Trusted Wireless 2.0 technology
- ✓ Adjustable data rates for the wireless interface
- ✓ 128-bit data encryption (AES)

# Product overview Radioline front modules



## 868 MHz wireless module

RAD-868-IFS (Europe) Order No. [2904909](#)

- Supply voltage: 19.2 V DC ... 30.5 V DC
- Adjustable transmission power of up to 500 mW
- Can be extended with I/O modules via DIN rail connectors
- Extended temperature range: -40°C ... +70°C
- Antenna connection: RSMA (female)
- Approvals: ATEX, IECEx
- Suitable for large distances with obstacles

## 900 MHz wireless module

RAD-900-IFS (America) Order No. [2901540](#)  
 RAD-900-IFS-AU (Australia, New Zealand) Order No. [2702878](#)

- Supply voltage: 10.8 V DC ... 30.5 V DC
- Adjustable transmission power of up to 1,000 mW
- Can be extended with I/O modules via DIN rail connectors
- Extended temperature range: -40°C ... +70°C
- Antenna connection: RSMA (female)
- Approvals: UL 508, HazLoc, FCC
- Suitable for large distances with obstacles

## 2.4 GHz wireless module

RAD-2400-IFS (worldwide) Order No. [2901541](#)  
 RAD-2400-IFS-JP (Japan) Order No. [2702863](#)

- Supply voltage: 19.2 V DC ... 30.5 V DC
- Adjustable transmission power of up to 100 mW
- Can be extended with I/O modules via DIN rail connectors
- Extended temperature range: -40°C ... +70°C
- Antenna connection: RSMA (female)
- Approvals: ATEX, IECEx, UL 508, HazLoc, FCC (RAD-2400-IFS only)

Radioline accessories can be found on page 33.

## One device – a wide range of applications

Radioline can transmit both I/O signals and serial data, and can therefore be used in a variety of applications – the Trusted Wireless technology ensures reliable transmission even in harsh industrial environments, regardless of the protocol type. The Radioline function blocks for PC Worx, STEP 7, and TIA Portal allow easy I/O integration in the control level.

### PC Worx/STEP 7 function blocks

- Free Radioline library
- Central monitoring of wireless stations in the control system



I/O data mode

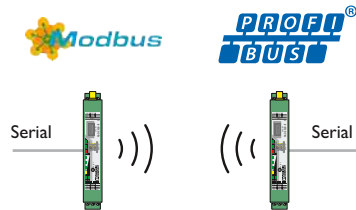

Serial data mode

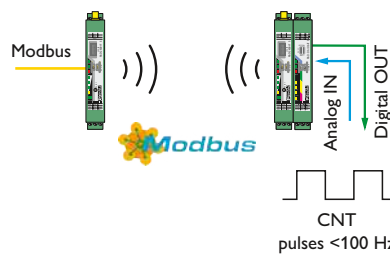

PLC/Modbus/RTU mode

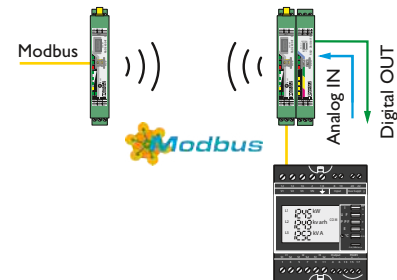

PLC/Modbus/RTU dual mode

## Wireless I/O

# Radioline – I/O mapping now also available in wired format

The popular, straightforward method of distributing I/O information using thumbwheels on the front of the equipment is now also available for RS-485 networks. Addressing the new RS-485 front module is quick and easy too – all it takes is a turn of the yellow thumbwheel. This enhances the Radioline system's flexibility, allowing you to use it for solutions in even more applications.



### Alternative transmission media

To increase the range, you can of course replace the RS-485 line with alternative transmission media. Phoenix Contact provides a range of converters for fiber-optic cables, SHDSL, wireless, or Ethernet technology.

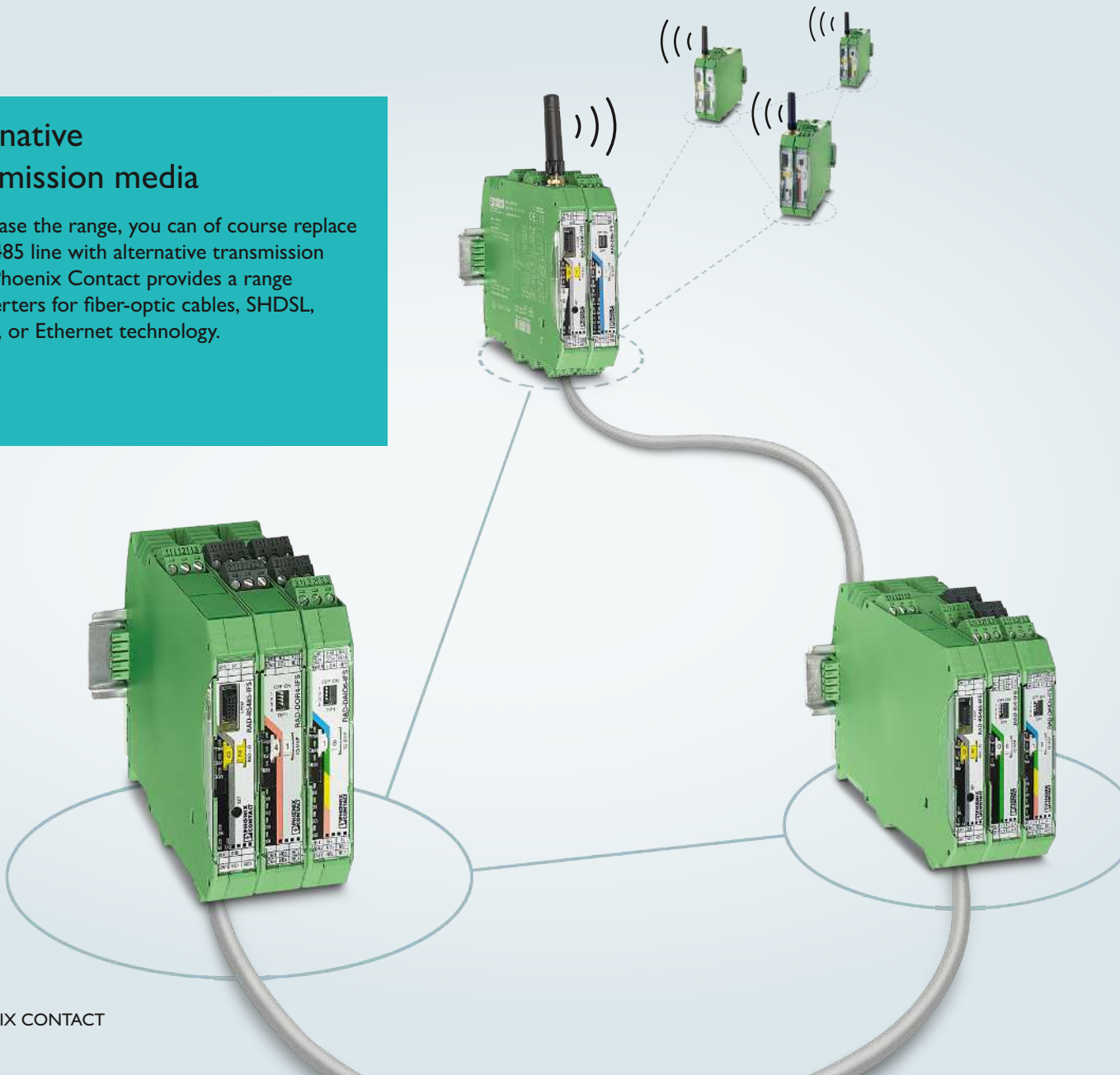

# Product overview Radioline bus module



## RS-485 bus module

RAD-RS485-IFS

Order No. [2702184](#)

- Extended temperature range: -40°C ... +70°C
- RS-485 2-wire connection (screw terminal block)
- Can be used worldwide
- Range: 1,200 m or more with converter or repeater
- Can be extended with I/O modules via DIN rail connectors
- Supply voltage: 19.2 V DC ... 30.5 V DC

## Signal transmission with the Radioline RS-485 bus module

A network may consist either entirely of wireless stations or entirely of RS-485 stations. Alternatively, it is also possible to combine a wireless network with RS-485 stations.

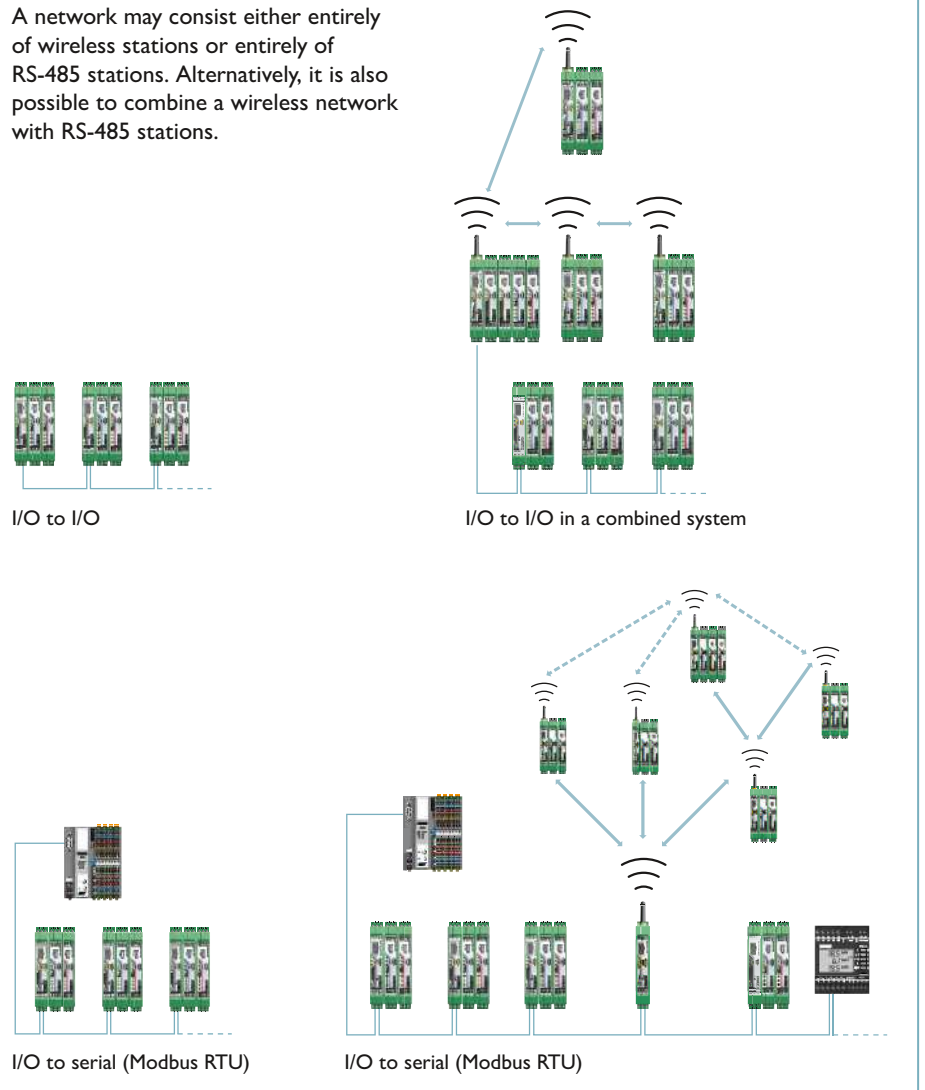

### Connection to the wireless system

A Radioline wireless system on an existing base station can be extended to include new RS-485 stations. The wireless and RS-485 modules form a combined system.

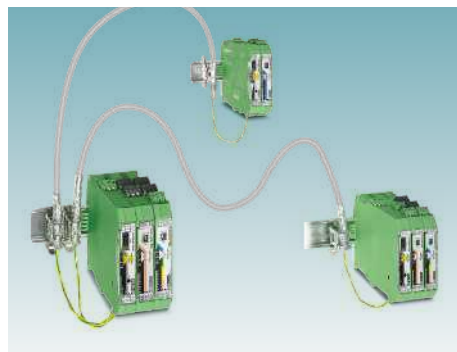

### Multipoint multiplexer

In an RS-485 network with up to 99 Radioline stations, you can now distribute I/O signals between stations entirely without the need for software configuration – all it takes is a turn of the thumbwheel.



### Stand-alone operation as a Modbus server

The new Radioline RS-485 stations can also be operated on any Modbus RTU client.

## Wireless I/O

# Radioline extension modules

Various extension modules are available for extending the Radioline wireless system quickly and easily. They allow the transmission of digital and analog signals as well as temperature signals.

All extension modules are certified in accordance with 94/9/EC (ATEX) directives, and can therefore be used internationally in potentially explosive areas.

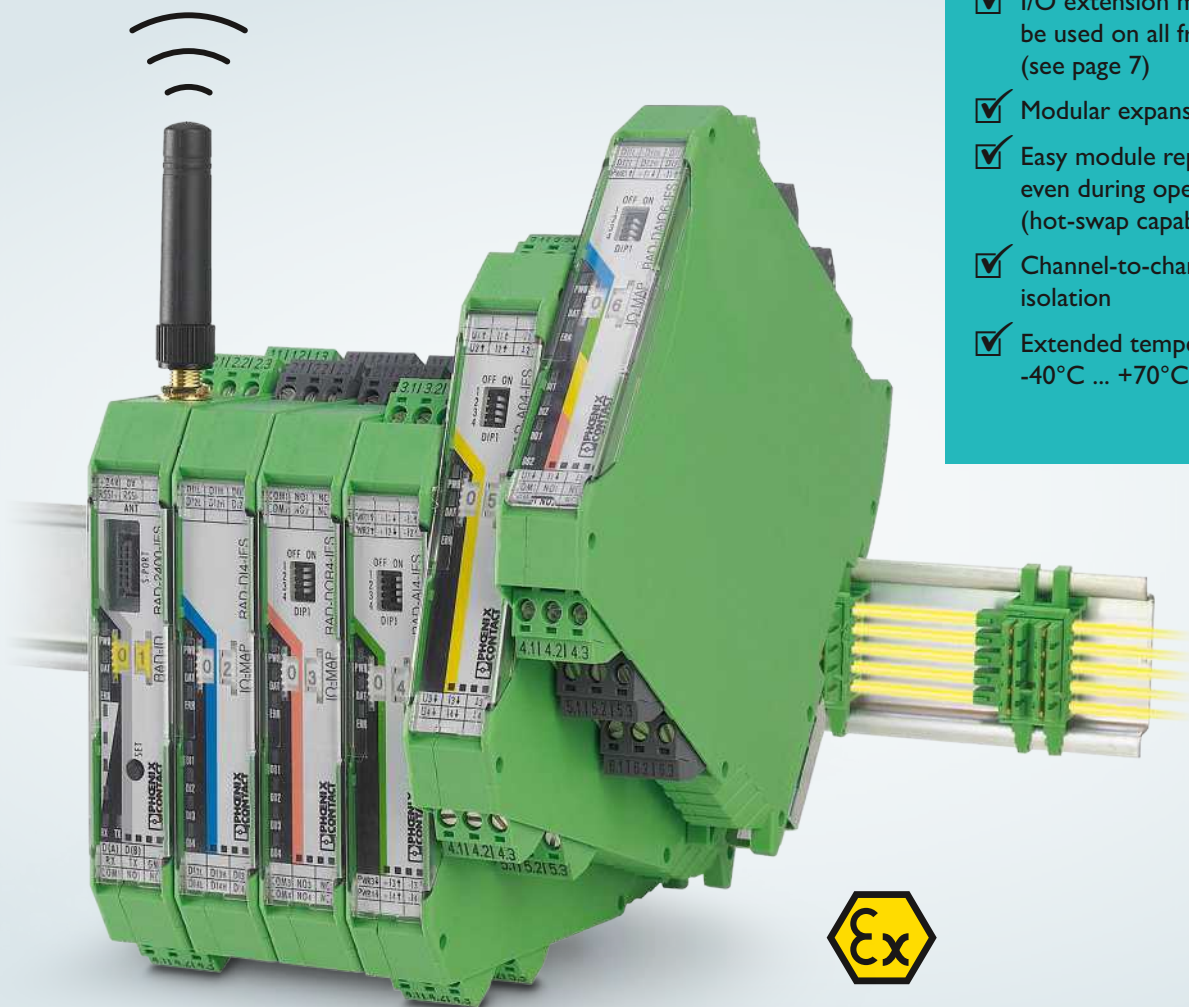

### Your advantages

- ✓ I/O extension modules can be used on all front modules (see page 7)
- ✓ Modular expansion possible
- ✓ Easy module replacement, even during operation (hot-swap capability)
- ✓ Channel-to-channel electrical isolation
- ✓ Extended temperature range: -40°C ... +70°C



# Product overview Radioline extension modules



## Digital extension modules

RAD-DI4-IFS Order No. [2901535](#)  
 RAD-DOR4-IFS Order No. [2901536](#)

- 4 digital wide-range inputs:  
0 V AC/DC ... 250 V AC/DC
- 4 digital relay outputs:  
24 V DC / 250 V AC / 5 A

RAD-DI8-IFS Order No. [2901539](#)  
 RAD-DO8-IFS Order No. [2902811](#)

- 8 digital inputs: 0 V DC ... 30.5 V DC
- 2 pulse inputs: 100 Hz, 32 bit
- 8 digital transistor outputs:  
30.5 V DC / 200 mA

RAD-NAM4-IFS Order No. [2316275](#)

- 4 digital NAMUR inputs
- Line break detection
- Short-circuit detection
- Can be combined with RAD-DO8-IFS

## Analog/Pt 100 extension module

RAD-AI4-IFS Order No. [2901537](#)

- 4 analog inputs:  
alternatively 0/4 ... 20 mA

RAD-AI4-U-IFS Order No. [2702290](#)

- 4 analog inputs: 0 ... 5/10 V

RAD-AO4-IFS Order No. [2901538](#)

- 4 analog outputs:  
alternatively 0/4 ... 20 mA, 0 ... 10 V DC

RAD-PT100-4-IFS Order No. [2904035](#)

- 4 Pt 100 inputs
- Temperature measuring range:  
-50°C ... +250°C
- 2-/3-conductor connection
- Can be combined with RAD-AO4-IFS

## Analog/digital extension module

RAD-DAIO6-IFS Order No. [2901533](#)

- 1 analog input:  
alternatively 0/4 ... 20 mA
- 1 analog output:  
alternatively 0/4 ... 20 mA, 0 ... 10 V DC
- 2 digital wide-range inputs/outputs:  
0 ... 250 V AC/DC



## Easy installation

Create a modular wireless station in the control cabinet and extend or replace it easily during operation.



## Unique addresses for front modules

Set a unique address on the front module by simply turning the thumbwheel.

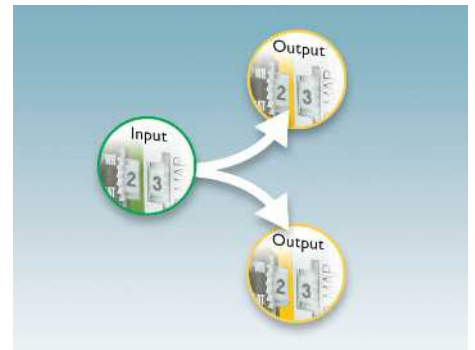

## Distribute inputs and outputs

On the I/O module, the thumbwheel is used to assign the inputs and outputs by creating pairs, thereby easily distributing the I/O signals in the system (I/O mapping).

## Wireless Serial

# Radioline for wireless networking of serial interfaces

The wireless module can be used to wirelessly network multiple controllers or serial I/O devices quickly and easily via RS-232 and RS-485 serial interfaces. Data transmission is transparent, which means that any protocols, such as Modbus, can be forwarded. Furthermore, various network structures can be realized: From a simple point-to-point connection all the way to complex mesh networks.



TRUSTED  
WIRELESS™



### Your advantages

- ✓ Quick and easy startup
- ✓ Easy point-to-point or network connections (star, mesh)
- ✓ Can be extended with up to 32 I/O modules per station via DIN rail connector (hot-swap capability)
- ✓ I/O-to-I/O, I/O-to-serial, serial-to-serial
- ✓ Trusted Wireless 2.0 technology
- ✓ Adjustable data rates for the wireless interface (16 kbps ... 500 kbps)
- ✓ 128-bit data encryption (AES)



RS-232  
RS-485





# Product overview Radioline



## Wireless module

- RAD-868-IFS (Europe) Order No. [2904909](#)
- RAD-900-IFS (Canada, North/South America) Order No. [2901540](#)
- RAD-2400-IFS (worldwide) Order No. [2901541](#)
- RAD-2400-IFS-JP (Japan) Order No. [2702863](#)

- Integrated RS-232 and RS-485 interface
- Can be extended with I/O modules via DIN rail connectors
- Extended temperature range: -40°C ... +70°C

## I/O extension modules

- Digital IN:
  - RAD-DI4-IFS Order No. [2901535](#)
  - RAD-DI8-IFS Order No. [2901539](#)
  - RAD-NAM4-IFS Order No. [2316275](#)
- Digital OUT:
  - RAD-DOR4-IFS Order No. [2901536](#)
  - RAD-DO8-IFS Order No. [2902811](#)
- Analog/digital IN/OUT:
  - RAD-DAIO6-IFS Order No. [2901533](#)

- Analog IN:
  - RAD-AI4-IFS Order No. [2901537](#)
  - RAD-AI4-U-IFS Order No. [2702290](#)
- Analog OUT:
  - RAD-AO4-IFS Order No. [2901538](#)
- Temperature IN:
  - RAD-PT100-4-IFS Order No. [2904035](#)

Radioline accessories are to be found on page 33.

## Replacement for serial cabling

Connect your controller to serial field devices using wireless technology. The remote stations are connected directly or via repeater intermediate stations. This means that you can connect up to 250 repeater stations in series

in order to extend the wireless path. Serial I/O devices and I/O extension modules can be connected to the intermediate stations.

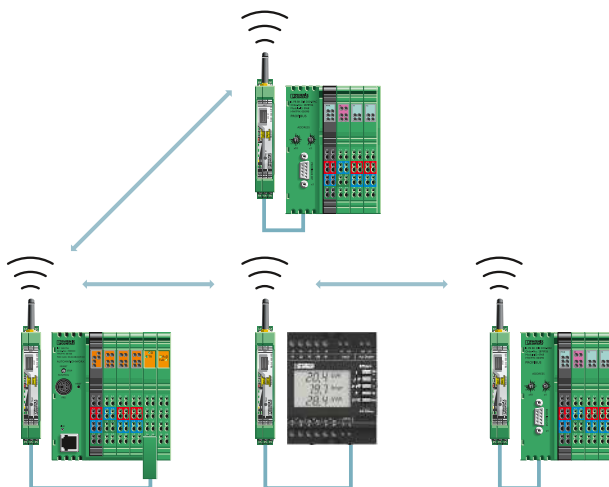

Wireless networking of serial devices

## Convenient software diagnostics

All network devices can be monitored conveniently via the base station.

- Online diagnostics:
  - Network structure design,
  - signal quality of each network station (RSSI), recording of RSSI signal and I/O status of each networked station
- Exclusion of up to two frequency bands (WLAN channels)
- Extended network settings

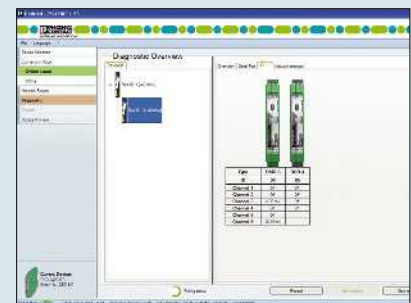

Comprehensive diagnostics

## Wireless Serial

# Radioline – solutions for use in outdoor applications

The Radioline Outdoor boxes can be installed outdoors in order to remotely transfer I/O signals or serial data quickly and easily. The device combinations are freely selectable. This enhances the Radioline system's flexibility, allowing you to use it for solutions in even more applications.



### Your advantages

- ✓ Robust, impact-resistant, UV-resistant, and splash-proof outdoor housing (IP66/NEMA 4X)
- ✓ Pre-wired box allows immediate installation
- ✓ Intuitive startup and configuration
- ✓ Flexible in physical terms with ranges of up to several kilometers



# Product overview Radioline Outdoor boxes



## For worldwide use

RAD-RUGGED-BOX-CONF

Order No. [1091638](#)

- Wireless module (selectable): 868 MHz, 900 MHz, or 2,400 MHz
- Can be extended with up to three selectable I/O extension modules
- Serial RS-232/RS-485 interface
- Including surge protection, antenna feed-through, and a pressure compensation element
- Ambient temperature: -25°C ... 55°C
- Universal power supply unit: 100 V AC ... 240 V AC
- Degree of protection: IP66
- Antenna connection: N (female)
- Approvals: CE

## For use in America

RAD-900-DAIO6

Order No. [2702877](#)

- Integrated 900 MHz wireless module
- 6 integrated I/O channels (2 x DI/DO, 1 x AI/AO)
- Connection to RAD-900-IFS wireless modules possible
- Ambient temperature: -40°C ... 65°C
- Universal power supply unit: 100 V AC ... 240 V AC / 10.8 V DC ... 30.5 V DC
- Degree of protection: NEMA 4X (IP66)
- Antenna connection: N (female)
- Approvals: ANSI/ISA/CSA 22.2 61010-2-201, UL 50E Type 4, Class I, Div. 2, Groups A, B, C, D T4, Class I, Zone 2, IIC T4

Radioline accessories can be found on page 33.

## Application examples for Radioline Outdoor boxes

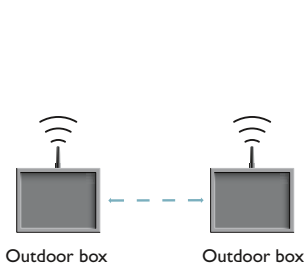

Point-to-point connection with two Outdoor boxes

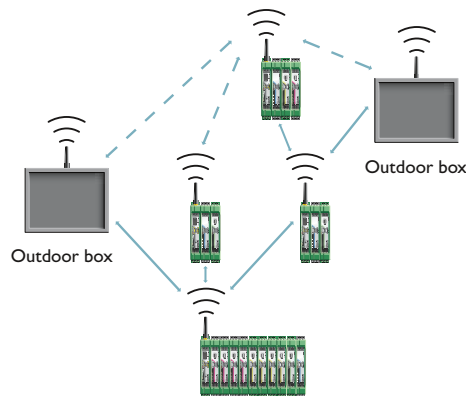

Point-to-point/star/mesh connection with standard wireless modules and Outdoor boxes

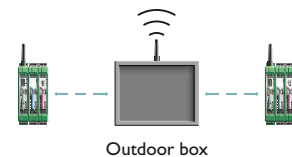

Mesh network with one Outdoor box as a simple repeater

## Wireless Ethernet

# NearFi coupler

The new NearFi technology extends the Phoenix Contact wireless portfolio. It transmits power and real-time Ethernet data contactlessly, and therefore allows completely new latency-free communication capabilities in the close-proximity range of up to 10 mm. The new NearFi couplers are a simple replacement for connections subject to wear and slip rings in industrial applications and will minimize costs caused by failures.



## NearFi Technology

Designed by Phoenix Contact

### Your advantages

- ✓ Contactless – no wear, no maintenance
- ✓ Protocol-independent, latency-free real-time communication with 100 Mbps (full duplex)
- ✓ High power in a compact housing
- ✓ High degree of mounting freedom with flexible proximity options
- ✓ All-around visible diagnostics with LED ring on the housing

# Product overview NearFi couplers



## Power and data couplers

NEARFI PD 2A ETH B Order No. [1234224](#)  
Base

NEARFI PD 2A ETH R Order No. [1234225](#)  
Remote

- Power up to 50 W (24 V/2 A)
- Data speed up to 100 Mbps (full duplex)

## Power couplers

NEARFI P 2A B Order No. [1234226](#)  
Base

NEARFI P 2A R Order No. [1234229](#)  
Remote

- Power up to 50 W (24 V/2 A)

## Data couplers

NEARFI D ETH B Order No. [1234232](#)  
Base

NEARFI D ETH R Order No. [1234234](#)  
Remote

- Data speed up to 100 Mbps (full duplex)

## NearFi couplers in an application

In industrial automation, power and data are often transmitted via connectors. Wherever connectors are connected and disconnected frequently, for example during tool changes on robots, connector service life is limited because contacts can become soiled or warped. The new NearFi power and data couplers in an IP65 housing with

M12 connection technology make wear and maintenance-free communication without contact possible across air gaps of up to 10 mm.



## Possible areas of application

The main fields of application for the new NearFi power and data couplers are in the following industries:

- Automotive industry
- Machine building and systems manufacturing
- Industrial robots
- Logistics



NearFi technology in the automotive industry

## Wireless Ethernet

# Bluetooth Low Energy

Industrial sensors with Bluetooth Low Energy interface provide new opportunities for condition monitoring, predictive maintenance, and the documentation of production parameters.

The robust BLE 1300 wireless module makes the data acquired from these sensors available to PLCs and cloud applications. The BLE 1300 can also perform a simple evaluation of the sensor data itself – for cost-effective solutions without a PC or controller.



### Your advantages

- ✓ Reduction of downtimes with maintenance- and wear-free transmission
- ✓ Future-proof integration of almost all Bluetooth Low Energy sensors
- ✓ Reliable and long-term operation, even in industrial environments
- ✓ Connection of up to eight sensors
- ✓ Space-saving use in industrial environments



# Product overview BLE 1300 wireless module



## Wireless module

FL BLE 1300

Order No. [1118418](#)

The compact FL BLE 1300 wireless module with integrated antenna can be installed practically anywhere. The device is also ideally suited for harsh ambient conditions – precisely where the sensors are also located. Easy mounting via two drill-holes directly onto a housing wall saves time and money.

- Bluetooth Low Energy 5.0
- Degree of protection: IP65
- Integrated antenna
- LEDs for diagnostics and status indicator
- Central and peripheral mode
- QUICKON M12 fast connection technology

## Possible areas of application

In the field of predictive maintenance, Bluetooth Low Energy supplies sensor data on vibrations and temperatures over a long time period, and can provide key information on how wear develops. A large number of tools and measuring equipment already have an integrated Bluetooth Low Energy wireless interface. These are used for acquiring key production data on critical components.



Motors and pumps in an industrial facility

## Bluetooth Low Energy in an application

Access to the BLE 1300, and therefore to up to eight sensors via TCP, allows the simple and flexible integration of almost all controllers and PC-based software systems. The wireless module therefore closes the

gap between sensors and the machine. Alternatively, the BLE 1300 can also perform simple monitoring tasks independently, without an additional PLC.



## Wireless Ethernet

# Industrial Bluetooth

The industrial Bluetooth modules allow you to wirelessly transmit control data to mobile or difficult-to-access automation devices quickly and easily. Bluetooth communication is characterized by particularly robust transmission under difficult ambient conditions.

The FL EPA 2 wireless modules allow you to transmit industrial protocols such as PROFINET without any problems. You can also realize functionally safe communication, via PROFIsafe or SafetyBridge Technology.



### Your advantages

- ✓ Easy and secure installation
- ✓ Extremely reliable and robust data transmission with redundant transmission channels and integrated error correction
- ✓ Interference-free parallel operation between Bluetooth and WLAN wireless paths with the efficient use of frequency gaps

SafetyBridge Technology<sup>®</sup>  
Designed by Phoenix Contact



# Product overview Industrial Bluetooth



## Bluetooth Ethernet adapter

FL BT EPA 2

Order No. [1005869](#)

- Internal antenna
- Bluetooth (PAN profile)



## Wireless Ethernet adapter

FL EPA 2

Order No. [1005955](#)

- Internal antenna
- Bluetooth (PAN profile)
- WLAN 80211 a/b/g/n (access point and client)



## Wireless Ethernet adapter

FL EPA 2 RSMA

Order No. [1005957](#)

- External, replaceable antenna (supplied, connection: RSMA (male))
- Bluetooth (PAN profile)
- WLAN 80211 a/b/g/n (access point and client)

### Technical data:

- Frequency band: 2.4 GHz/5 GHz
- 128-bit data encryption, WLAN black channel list, low emission mode (LEM)
- Degree of protection IP65
- M12 connections for power and LAN

- Auto crossing, PROFINET prioritization, LLDP
- Power supply: 9 V DC ... 30 V DC
- Temperature range: -40°C ... +65°C
- UL/cUL Class 1 Div 2 Hazardous location

- Configuration via MODE button, web interface, SNMP and AT commands
- Accessories: Assembly adapter ([2701134](#)), DIN rail adapter ([2701133](#))

## Bluetooth applications

The Bluetooth BT EPA 2 modules replace individual Ethernet or PROFINET cables leading to automation devices with a reliable wireless connection.

They allow up to seven Bluetooth modules to be connected to the Ethernet network at the same time.

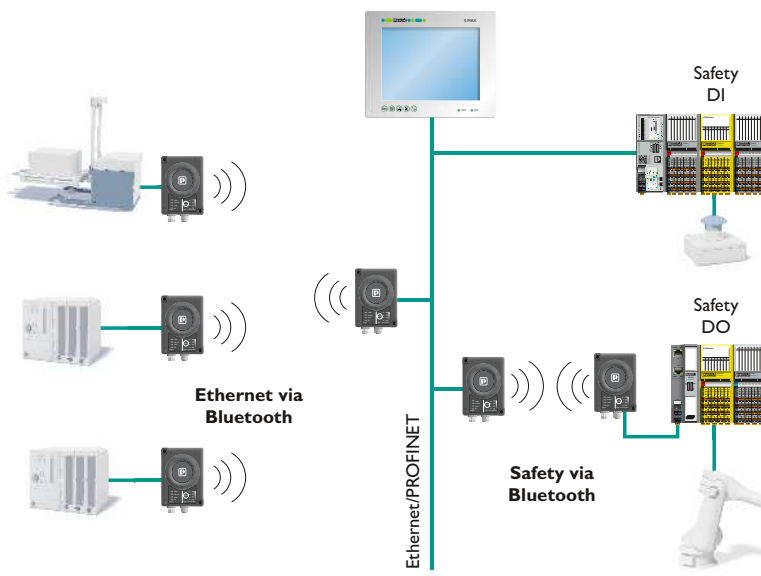

## Possible areas of application

Bluetooth allows mobile devices to be integrated into industrial control networks wirelessly, thereby eliminating the need for expensive cable runs that are prone to wear.

- Robots and traveling robots
- Handling machines, packaging machines, pallet wrapping machines
- Moving machine parts
- Cranes and lifting equipment



Industrial Bluetooth on cranes

## Wireless Ethernet

# Industrial WLAN

Use industrial WLAN components for wireless machine access with smart devices or as robust communication with mobile machine parts. Industrial wireless systems also provide for more flexibility and efficiency for reliable communication between controller and autonomous transport systems, warehouse shuttles, or carry systems.

The industrial WLAN components support you with the implementation of high-performance and modern MIMO technology.



### Your advantages

- ✓ Easy and reliable creation of industrial WLAN networks
- ✓ Particularly secure with the latest security standards and encryption
- ✓ Ideal for networks with a large number of devices
- ✓ Maximum mobility with fast roaming functions
- ✓ Suitable for time-critical applications such as PROFINET or Safety



# Product overview Industrial WLAN



## WLAN 5110 access point

FL WLAN 5110 (EU) Order No. [1043193](#)  
 FL WLAN 5111 (USA, CAN) Order No. [1043201](#)  
 SD-FLASH 2 GB Order No. [2988162](#)

- IEEE 802.11 a/b/g/n, WLAN access point, client, repeater, frequency band 2.4 GHz and 5 GHz, MIMO technology 2x2:2, up to 300 Mbps, cluster management

## WLAN 1100 wireless module

IP54:  
 FL WLAN 1100 (EU) Order No. [2702534](#)  
 FL WLAN 1101 (USA, CAN) Order No. [2702538](#)

IP65/IP66/IP67/IP68, extended temperature range:

FL WLAN 2100 (EU) Order No. [2702535](#)  
 FL WLAN 2101 (USA, CAN) Order No. [2702540](#)

- IEEE 802.11 a/b/g/n, WLAN access point and client, frequency band: 2.4 GHz and 5 GHz, 2 integrated antennas with MIMO technology, power supply: 9 ... 32 V DC, WLAN mesh with WLAN 210x

## WLAN 1010/2010 wireless module

FL WLAN 1010 (EU) Order No. [2702899](#)  
 FL WLAN 1011 (USA, CAN) Order No. [2702900](#)  
 FL WLAN 2010 (EU) Order No. [1119246](#)  
 FL WLAN 2011 (USA, CAN) Order No. [1119248](#)

- Degree of protection: IP20
- 2 external antenna connections
- 2 virtual WLAN interfaces
- MAC and IP filter
- IEEE 802.11 a,b,g,n (2.4 GHz and 5 GHz)
- Data rates of up to 300 Mbps
- WLAN Mesh with WLAN 201x

## Typical WLAN network structure

The powerful WLAN 5110 and the compact WLAN 1100 are the perfect complements for wireless communication in the machine environment.

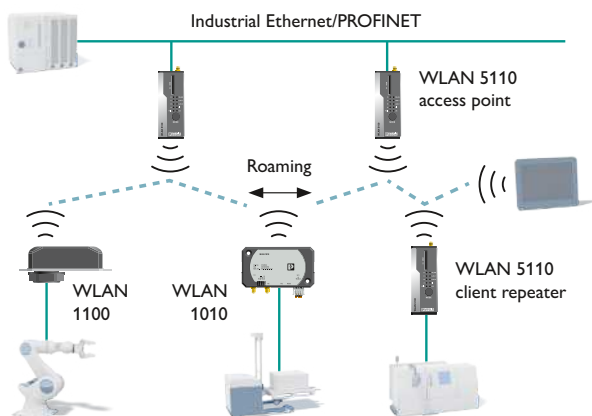

Wireless machine communication with industrial WLAN

## Connecting smart devices

The WLAN 1100 facilitates easy connection of smart devices to machines and systems.

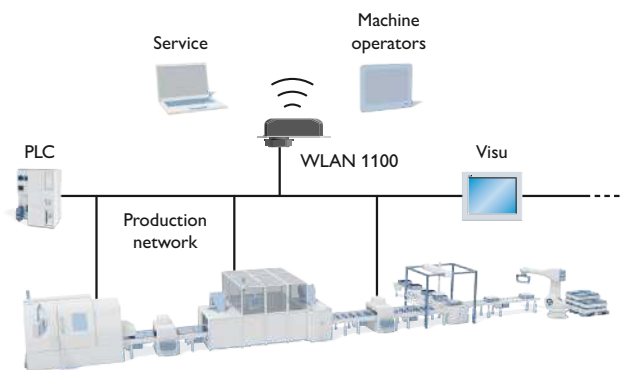

Wireless machine operation and service with wireless LAN

## Wireless Ethernet

# Cellular routers and remote maintenance gateways for worldwide network access

Cellular routers and remote maintenance gateways allow high-performance remote connections to industrial Ethernet networks. This makes it possible to transmit sensitive data from machines and systems securely via the Internet. The integrated firewall and support for VPN (Virtual Private Network) protect against unauthorized access.

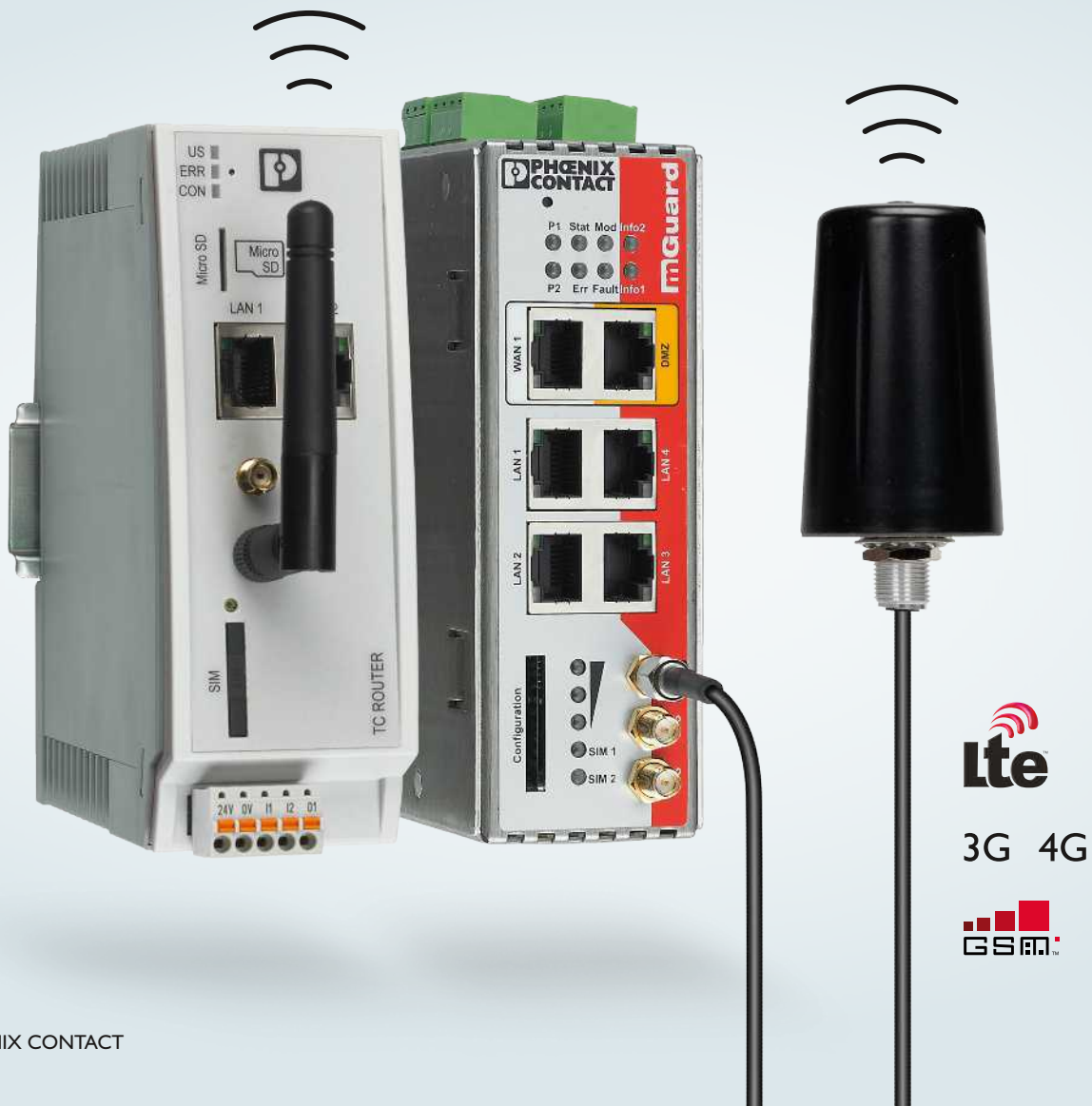

# Product overview 4G cellular routers and remote maintenance gateways



## Infrastructure cellular routers

### TC ROUTER...

... 2002T-4G	Order No. <a href="#">2702530</a>
... 3002T-4G	Order No. <a href="#">2702528</a>
... 3002T-4G VZW	Order No. <a href="#">2702532</a>
... 3002T-4G ATT	Order No. <a href="#">2702533</a>
... 4002T-4G EU	Order No. <a href="#">1234352</a>
... 4102T-4G EU WLAN	Order No. <a href="#">1234353</a>
... 4202T-4G EU WLAN	Order No. <a href="#">1234354</a>

- Alerts via SMS and e-mail
- Support for IPsec and OpenVPN (TC ROUTER 3002T and 4002T)
- Temperature range: -40°C ... +70°C

## Remote maintenance gateways

### CLOUD CLIENT...

... 1002-4G	Order No. <a href="#">2702886</a>
... 1002-4G VZW	Order No. <a href="#">2702887</a>
... 1002-4G ATT	Order No. <a href="#">2702888</a>
... 2002T-4G EU	Order No. <a href="#">1234355</a>
... 2102T-4G EU WLAN	Order No. <a href="#">1234357</a>
... 2002T-WLAN	Order No. <a href="#">1234360</a>
... 1101T-TX/TX	Order No. <a href="#">1221706</a>

- Turnkey VPN tunnel with configuration assistant for the mGuard Secure Remote Service
- Connection for key switch

## Security routers 4G (LTE)

### TC MGUARD...

... RS4000 4G VPN	Order No. <a href="#">2903586</a>
... RS2000 4G VPN	Order No. <a href="#">2903588</a>
... RS4000 4G VZW VPN	Order No. <a href="#">1010461</a>
... RS2000 4G VZW VPN	Order No. <a href="#">1010462</a>
... RS4000 4G ATT VPN	Order No. <a href="#">1010463</a>
... RS2000 4G ATT VPN	Order No. <a href="#">1010464</a>

- Central management tool
- Easy integration with integrated Ethernet switch
- Compatible with mGuard Secure Remote Service

## Data links

- Worldwide Internet data link via cellular networks
- Flexible use in small machines all the way to larger system networks
- Secure VPN communication

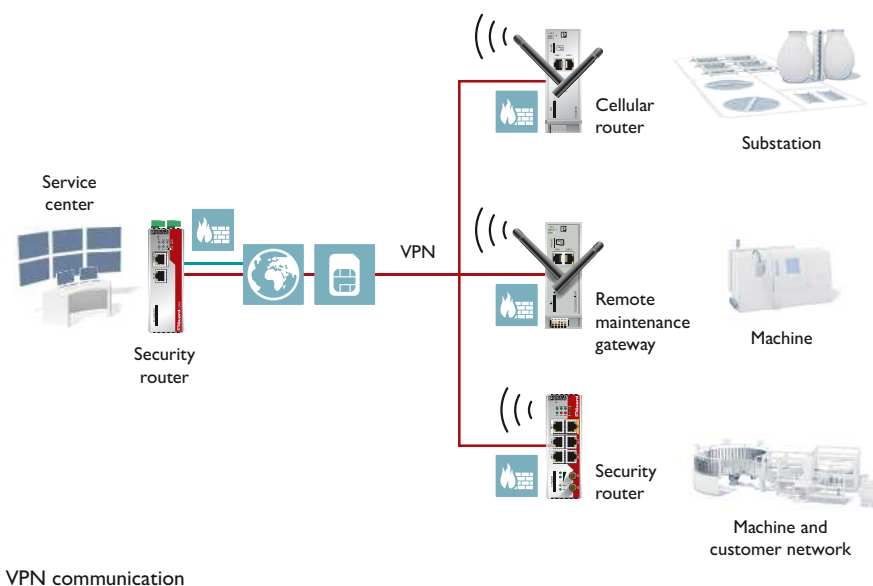





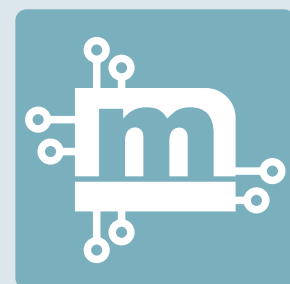



## Remote maintenance via the Cloud



The mGuard Secure Remote Service securely connects service personnel and remote maintenance locations via the Internet in the framework of an encrypted VPN complete solution. Service personnel connect quickly and securely to machines, industrial PCs, and controllers via a simple web interface. In addition, secure remote maintenance can be performed at any location and any time without requiring specialist IT knowledge.





mGuard Secure Remote Service



# Product overview for antennas and accessories



Antennas					
<b>868 MHz</b>					
	Description	Gain	Connection	Features	Order No.
	Omnidirectional antenna, vandalism proof	2.5 dBi	N (female)	Temperature range: -40°C ... +75°C, degree of protection: IP65, including mounting bracket	1090616
	Omnidirectional antenna, salt water resistant 	4 dBi	N (female)		2702136
	Directional antenna for panel, saltwater-resistant 	3.5 dBi	N (female)		2702137
	Yagi directional antenna	8.5 dBi	N (female) With 0.6 m cable		2867814
Yagi directional antenna	12 dBi	N (female) With 0.6 m cable	5606614		
<b>900 MHz</b>					
	Omnidirectional antenna	2 dBi	RSMA (male) With 1.5 m cable	Temperature range: -40°C ... +80°C, degree of protection: IP65, including mounting bracket	2904801
	Omnidirectional antenna	2 dBi	N (female)		2904802
	Omnidirectional antenna	5 dBi	N (female)		2867791
	Omnidirectional antenna	7 dBi	N (female)		2867199
	Yagi directional antenna	5 dBi	N (female) With 0.6 m cable		2867801
	Yagi directional antenna	8.5 dBi	N (female) With 0.6 m cable		2867814
	Yagi directional antenna	12 dBi	N (female) With 0.6 m cable		5606614
<b>2.4 GHz</b>					
	Omnidirectional antenna	2 dBi	RSMA (male) With 1.5 m cable	Temperature range: -40°C ... +70°C, degree of protection: min. IP65, including mounting bracket	2701362
	Omnidirectional antenna, vandalism proof	3 dBi	RSMA (male) With 1.5 m cable		2701358
	Bracket for wall mounting	–	For antennas with protection against vandalism		2885870
	Omnidirectional antenna, salt water resistant 	6 dBi	N (female)		2885919
<b>5 GHz</b>					
	Omnidirectional antenna	5 dBi	N (female)	Temperature range: -40°C ... +70°C, degree of protection: min. IP65, including mounting bracket	2701347
<b>2.4 GHz and 5 GHz</b>					
	Omnidirectional antenna	2.5 dBi at 2.4 GHz 5 dBi at 5 GHz	N (male)	Temperature range: -40°C ... +70°C, degree of protection: min. IP65	2701408
	Omnidirectional antenna, vandalism proof	Up to 6 dBi at 2.4 GHz Up to 8 dBi at 5.6 GHz	N (female)		2702898
	Directional antenna for panel, saltwater-resistant 	9 dBi	N (female)		2701186
	Omnidirectional antenna	2 dBi at 2.4 GHz 2 dBi at 5 GHz	RSMA (male)		1284777
	Omnidirectional antenna	2 dBi at 2.4 GHz 2 dBi at 5 GHz	N (male)		1284780

Antenna cable			
N (male) > N (male)			
	Description	Frequency	Order No.
	0.5 m	0.3 GHz ... 6 GHz	2700677
	3 m	0.3 GHz ... 6 GHz	2867649
	5 m	0.3 GHz ... 6 GHz	2867652
	10 m	0.3 GHz ... 6 GHz	2867665
	15 m	0.3 GHz ... 6 GHz	2885634
	6 m	900 MHz	5606125
	15 m	900 MHz	2867225
	30 m	900 MHz	2867238
	RSMA (male) > N (male)		
	0.5 m	0.3 ... 6 GHz For the control cabinet feed-through	2701402
	0.5 m	0.3 GHz ... 6 GHz	2903263
	1 m	0.3 GHz ... 6 GHz	2903264
	2 m	0.3 GHz ... 6 GHz	2903265
	3 m	0.3 GHz ... 6 GHz	2903266
	5 m	0.3 GHz ... 6 GHz	2702140



Accessories					
Adapters and antenna splitters					
	Description	Frequency	Connection	Features	Order No.
	Adapter	0.3 GHz ... 6 GHz	N (female) > N (female)	For the control cabinet feed-through	2867843
	Adapter, 90° angled	0.3 GHz ... 6 GHz	RSMA (male) > RSMA (female)	For control cabinets with little room	2904790
	Antenna splitter	0.3 GHz ... 6 GHz	3 x N (female)	2-way splitter	2702293
	DIN rail adapter	–	–	DIN rail mounting, WLAN 101x/201x	1178237
Surge protection					
	Surge protection	868 MHz, 900 MHz	N (female) > N (female)	For the control cabinet feed-through	2803166
	Surge protection, with Lambda/4 technology	2.4 GHz 5 GHz			2838490

## Product overview for antennas and accessories

Accessories				
Leaky wave cables (LCX)				
	Description	Features		Order No.
	Leaky wave cable 2.4 GHz	Longitudinal loss: 14.7 dB/100 m, coupling attenuation 95%: 60 dB, temperature range: -40°C ... +85°C		2702553
	Leaky wave cable 5 GHz	Longitudinal loss: 19.1 dB/100 m, coupling attenuation 95%: 71 dB, temperature range: -40°C ... +85°C		2702860
	Assembly tool	Planning tool for precise mounting of the connectors on the leaky wave cable		2702519
	Connector	Connector for leaky wave cables N (female)		2702518
	Cable tie	Mounting clamp for securing the leaky wave cable		2702520
	Termination resistor	N (male) required for capping the open leaky wave cable end		2884978
	Termination resistor	RSMA (male) for capping the open antenna port of the WLAN APs		2702702
Antenna impeding device for the Ex area				
	Description	Connection	Features	Order No.
	N connector, double-sided, 0.7 ... 6 GHz	 N (female) > N (female)	Installation in Ex zone 2, installation of standard antennas in zones 0, 1, 2	2702198

Cellular communication accessories					
Omnidirectional antennas					
	Description	Technology	Connection	Features	Order No.
	Omnidirectional antenna	2G/3G	2 m antenna cable, with SMA circular connector	For mounting on the control cabinet	2313371
	Combined omnidirectional antenna with GPS	2G/3G/GPS	2 m antenna cable, SMA for cellular communication, RSMA for GPS	For mounting on the control cabinet	2903590
	Omnidirectional antenna	2G/3G/4G/5G	5 m antenna cable, with SMA circular connector	For wall or mast mounting	2702273
	Omnidirectional antenna	2G/3G/4G/5G	0.5 m antenna cable, with SMA circular connector	For wall or mast mounting	2702274
	Omnidirectional antenna	2G/3G	SMA circular connector (without antenna cable)	For mounting directly on the device	2313342
Antenna cable					
	Description	Attenuation	Connection	Features	Order No.
	5 m	0.23 dB/m ... 0.44 dB/m	SMA (male) > SMA (female)	Impedance: 50 Ω	2900980
	10 m				2900981



Cellular communication accessories				
<b>Angle adapter</b>				
	Description	Connection	Features	Order No.
	90° adapter	SMA (female) > SMA (male)	For connecting the GSM/UMTS antenna cable where space is restricted	2917324
<b>Surge protection set</b>				
	Description	Connection	Features	Order No.
	Intermediate plug	SMA connectors/socket	With Lambda/4 technology as surge protection for coaxial signal interfaces	2800491
<b>Sealing tape</b>				
	Description	Features		Order No.
	3 m	Self-vulcanizing, for external protection of adapters, splitters, or cable connections; watertight		2903182

Control box sets				
<b>For outdoor mounting</b>				
	Description	Features	Property	Order No.
	Set for constructing wireless systems	For industrial applications, IP65, with DIN rail, plugs, and screw connections, without devices	With omnidirectional antennas	1088098
			With omnidir. antennas and power supply unit	1088095
			With omnidirectional antennas and PoE splitter	1088097
Without antenna accessories			2701204	

Radioline accessories					
<b>Configuration memory, memory stick, and USB cable</b>					
	Description	Connection	Frequency	Features	Order No.
	Configuration memory RF band 3	S-PORT	2.4 GHz	For easy and secure network addressing with unique network ID	2902814
	Configuration memory RF band 5	S-PORT	2.4 GHz		2902815
	Configuration memory RF band 7	S-PORT	2.4 GHz		2902816
	Configuration memory RF band 1	S-PORT	868 MHz		2702197
	Configuration memory RF band 1	S-PORT	900 MHz		2702122
	Flash drive	S-PORT	For all Radioline front modules	Freely configurable	2902828
USB cable	USB/S-PORT	For all Radioline front modules	For diagnostics and configuration	2903447	

# You can count on us

You do not need to be an expert. We provide you with much more than just products. We also provide you with support whenever you need it.

Contact us for more information.



909 Ridgebrook Road., Sparks, Maryland 21152, USA  
TEL : +1-410-583-1701 FAX : +1-410-583-1704  
E-mail: sales@pulsesupply.com  
<https://www.pulsesupply.com/pc-iwr>



# Overview of our services



## Planning and consultation

Whether for failsafe network structures, protecting, or remotely maintaining your machinery or high-performance wireless networks, we will find the right solution for you.



## Configuration and startup

We provide support during the configuration and startup of your network and show how to optimize the performance, availability, and safety.



## Maintenance and support

If your network is not working in accordance with your expectations, we will eliminate any faults. We will analyze your network and assist you and provide recommendations.



## Training and workshops

Do you want to gain a better insight into network engineering for yourself or your staff? We provide perfectly tailored instruction and practical training.

## For professional wireless coverage

Give us the coordinates of the stations to be networked and we will check the feasibility using our wireless network planning software or by performing wireless path tests on site.

You will receive an extensive test report and a bill of materials including all required components.

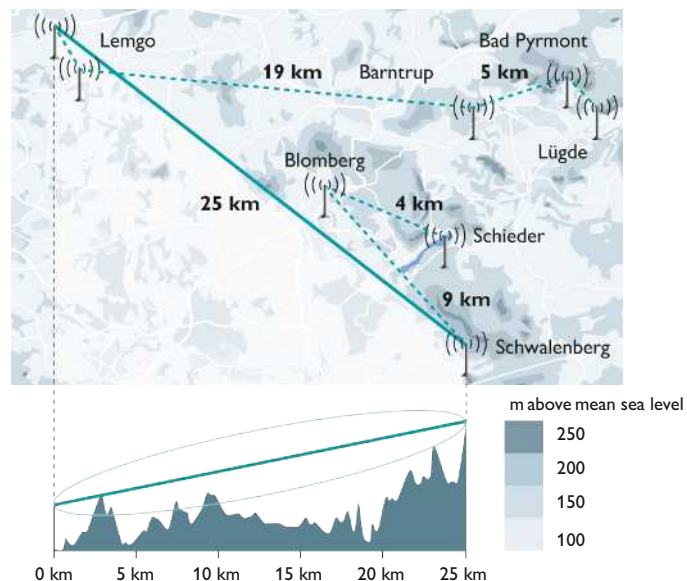

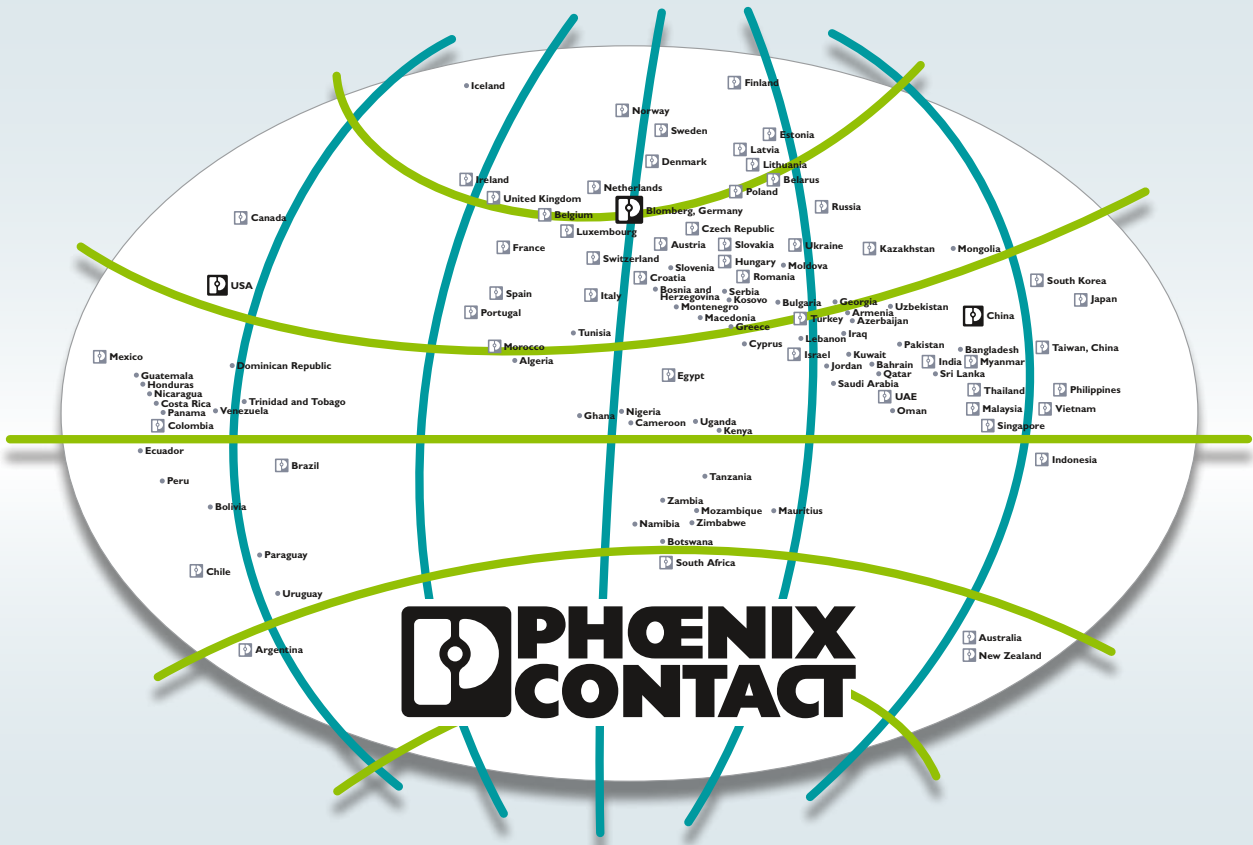

909 Ridgebrook Road., Sparks, Maryland 21152, USA  
 TEL : +1-410-583-1701 FAX : +1-410-583-1704  
 E-mail: sales@pulsesupply.com  
<https://www.pulsesupply.com/pc-iwr>