

MAX HD4 MBX

Upgradable Quad-Cellular Gigabit LTE Powerhouse

Quad Cellular Bandwidth Bonding



The HD4 MBX is capable of combining the bandwidth of up to 4 cellular links into an unbreakable, high-speed SD-WAN connection. The HD4 MBX supports up to 8 SIM cards, with room for another 8 with the optional SIM Injector. With up to 16 cellular providers to connect to, spotty coverage will simply not be a problem.

Compatible With



Ready for any Environment

The HD4 MBX is designed for industrial usage. With its fanless design, it thrives in high-particle environments that would break other fan-based routers. The HD4 MBX also comes with 8x 802.3at PoE outputs to power your IP phones, cameras, and access points. Finally, the MBX has the same dimensions as the previous HD4, so it can fit seamlessly into any of your previous deployments.



Ready to Move

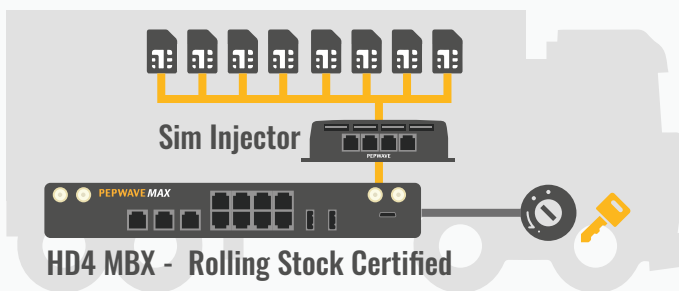

The HD4 MBX comes with multiple features to make it ideal for on-the-go deployments. Ignition Sensing gives it the ability to turn on and off depending on whether the vehicle has started. Upon vehicle shutdown, the MBX can also shut down after a user-defined interval, saving the battery from excessive drain.

The HD4 MBX supports the optional SIM Injector, which adds another 8 cellular providers to connect with. This mitigates weak spots in cellular coverage, ensuring consistent connectivity. If your deployment crosses national boundaries, you can also use the SIM Injector to load multiple SIM cards, preventing roaming charges. Finally, the HD4 MBX has rolling stock certification, meeting the strictest requirements of transportation deployments.

Gigabit LTE Ready for 5G

Right out of the box, the HD4 MBX supports Gigabit LTE. For future technologies, the MBX features a swappable cellular module, so when you need to upgrade to 5G, you can simply swap your old one with a new one. The MBX is also capable of 2.5Gbps of throughput, giving you plenty of bandwidth for Gigabit Ethernet, 5G, or any future mobile technologies. 2.5Gbps also gives your wired connections plenty of room to operate in concert with wireless connections, building network resilience and ensuring that your branch office stays up.

Upgradable Cellular Module, 5G.



MAX HD4 MBX

Upgradable Multi-Cellular Gigabit LTE Powerhouse

Specifications

MAX HD4 MBX (CAT-12)	
WAN Interface	2x USB Interface 3x GE*
LAN Interface	4x Embedded LTE-A Pro Modems with Redundant SIM Slots 9x GE*
Wi-Fi Interface	802.11ac/a/b/g/n, 1166 Mbps 2x2 MIMO Wi-Fi WAN and/or AP Simultaneous Dual-Band
Router Throughput	2.5 Gbps
Number of PepVPN SpeedFusion Peers	2/20/50^
PepVPN Throughput (No Encryption)	600 Mbps
PepVPN Throughput (256-bit AES)	500 Mbps
LTE-A Pro Modems	4x Modems, Downlink/Uplink Per Modem: 600 Mbps/150 Mbps
Recommended Users	50-500
Cellular and GPS Antenna Connector	8x SMA Antenna Connectors 1x SMA GPS Antenna Connector 4x RP-SMA Wi-Fi Antenna Connectors
Power Input	DC Jack/Terminal Block: 12-56 V#
Power Output	Up to Eight 802.3at PoE Outputs#
Power Consumption	55 W (max.)
Dimensions	2.0 x 11.5 x 7.0 inches 50 x 292 x 177 mm
Weight	7.28 pounds 3.3 kg
Operating Temperature	-40 ° - 149 °F -40 ° - 65 °C
Humidity	15% - 95% (non-condensing)
Certifications	FCC, CE, RoHS, RCM, E-Mark, PTCRB, Shock and Vibration Resistance: EN 61373:1999 IEC 61373:1999 Railway Applications: EN 50155 Electromagnetic Compatibility: EN 61000
Warranty	1-Year Limited Warranty
Package Content	MAX HD4 MBX, 1x PSU 180W (ACW-630), 4x Wi-Fi Dual Band Antenna (ACW-341), 1x GPS Antenna (ACW-232), 8x LTE/5G Antennas (ACW-234), 1 Pair of Mounting Brackets (ACW-513), 3pin Terminal Block Connector (Ignition sense), 4pin Terminal Block Connector (Power supply), Grounding cable, Rubber Foot Pad set



CAT-12

HD4 MBX (CAT-12)

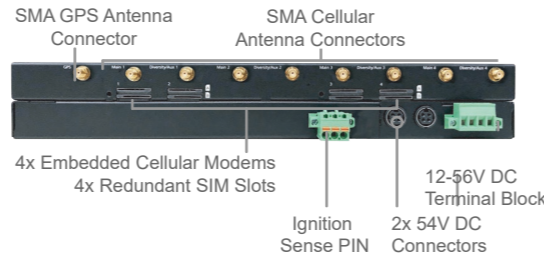
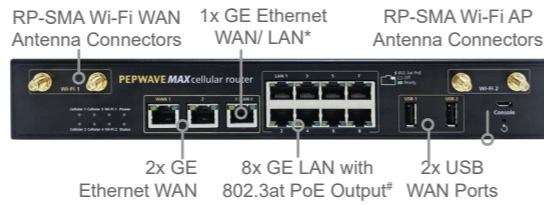

* WAN 3 is configured as a LAN port by default, configuration is changeable on the Web Admin.
2x 54V DC input is needed for all 8x LAN ports to have 802.3at PoE. Plugging in 1x 54V DC input will result in 4x LAN ports having 802.3at PoE.
^ With purchase of optional SpeedFusion License (MAX-HD-020-SPF/SFN-LC-50) can connect to up to 20/50 SpeedFusion peers respectively.

MAX HD2/HD4 MBX

Upgradable Multi-Cellular Gigabit LTE Powerhouse

Specifications

HD2 / HD4 MBX (CAT-18)	
WAN Interface	2x USB Interface 3x GE*
LAN Interface	HD2 MBX: 2x Embedded LTE-A Pro Modems with Redundant SIM Slots/ HD4 MBX: 4x Embedded LTE-A Pro Modems with Redundant SIM Slots 9x GE*
Wi-Fi Interface	802.11ac/a/b/g/n, 1166 Mbps 2x2 MIMO Wi-Fi WAN and/or AP Simultaneous Dual-Band
Router Throughput	2.5 Gbps
Number of PepVPN SpeedFusion Peers	2/20/50^
PepVPN Throughput (No Encryption)	600 Mbps
PepVPN Throughput (256-bit AES)	500 Mbps
LTE-A Pro Modems	Downlink/ Uplink Data rate: 1.2 Gbps/150 Mbps
Recommended Users	50-500
Cellular and GPS Antenna Connector	HD2 MBX: 8x SMA Antenna Connectors + 1x SMA GPS Antenna Connector HD4 MBX: 16x QMA Antenna Connectors + 1x QMA GPS Antenna Connector 4x RP-SMA Wi-Fi Antenna Connectors
Power Input	DC Jack/ Terminal Block: 12-56 V#
Power Output	Up to Eight 802.3at PoE Outputs#
Power Consumption	55 W (max.)
Dimensions	2.0 x 11.5 x 7.0 inches 50 x 292 x 177 mm
Weight	7.28 pounds 3.3 kg
Operating Temperature	-40 ° - 149 °F -40 ° - 65 °C
Humidity	15% - 95% (non-condensing)
Certifications	FCC, CE, RoHS, E-Mark, PTCRB, Shock and Vibration Resistance: EN 61373:1999 IEC 61373:1999 Railway Applications: EN 50155 Electromagnetic Compatibility: EN 61000 ESN (Emergency Services Network)
Warranty	1-Year Limited Warranty
Package Content	MAX HD2 MBX, 1x PSU 180W (ACW-630), 4x Wi-Fi Dual Band Antenna (ACW-341), 1x GPS Antenna (ACW-232), 8x LTE/5G Antennas (ACW-234), 1 Pair of Mounting Brackets (ACW-513), 3pin Terminal Block Connector (Ignition sense), 4pin Terminal Block Connector (Power supply), Grounding cable, Rubber Foot Pad set MAX HD4 MBX, 1x PSU 180W (ACW-630), 1x QMA to SMA Adaptor (for GPS), 1x GPS Antenna (ACW-232), 1 Pair of Mounting Brackets (ACW-513), 4x Wi-Fi Dual Band Antenna (ACW-341), 3pin Terminal Block Connector (Ignition sense), 4pin Terminal Block Connector (Power supply), Grounding cable, Rubber Foot Pad set

Ordering Information

Product Code	Description	Carrier/Category	Embedded Modems	4G Bands	3G Bands
MAX-HD2-MBX-GLTE-G-T	Includes 1x 54V Power Supply and PoE License. Enables 4x 802.3at PoE Output Ports	Global / ESN / CAT-18	2	B1, B3, B25(B2), B66(B4), B26(B5/B18/B19), B7, B8, B12(17), B13, B14, B20, B28, B29, B30, B32, B71, B38, B39, B40, B41, B42, B43, B46, B48	B1, B2, B4, B5(B19), B8
MAX-HD4-MBX-GLTE-G-T	Includes 1x 54V Power Supply and PoE License. Enables 4x 802.3at PoE Output Ports	Global / ESN / CAT-18	4	B1, B3, B25(B2), B66(B4), B26(B5/B18/B19), B7, B8, B12(17), B13, B14, B20, B28, B29, B30, B32, B71, B38, B39, B40, B41, B42, B43, B46, B48	B1, B2, B4, B5(B19), B8

Custom Options

Product Code	Description
ACW-630	Includes 1x 54V, 3.34A Power Supply Enable 4x LAN with 802.3at PoE output (PoE License automatically applied after kit purchase)
ACW-633	Includes 2x 54V, 3.34A Power Supply Enables 8x LAN with 802.3at PoE output (PoE License automatically applied after kit purchase)
MAX-HD-020-SPF	Supports up to 20 PepVPN/SpeedFusion Peers
SIM-BK8-4E-56V	SIM Injector, 8x SIM cards capacity, 4x 10/100/1000 LAN ports, 56V DC
SFN-LC-50	Up to 50 SpeedFusion Bonding License Key for MAX HD2/HD4 MBX
ANT-MB-42G-S-W-6	7-in-1 Cellular and Wi-Fi Antenna System with GPS Receiver (White)
ANT-MB-42G-S-B-6	7-in-1 Cellular and Wi-Fi Antenna System with GPS Receiver (Black)
ANT-MB-42G-Q-W-6	7-in-1 Cellular and Wi-Fi Antenna System with GPS Receiver (White)
ANT-MB-42G-Q-B-6	7-in-1 Cellular and Wi-Fi Antenna System with GPS Receiver (Black)
ANT-MB-40G-Q-W-6	5-in-1 Cellular Antenna System with GPS Receiver (White)
ANT-MB-40G-Q-B-6	5-in-1 Cellular Antenna System with GPS Receiver (Black)

CAT-18



HD2/4 MBX (CAT-18)

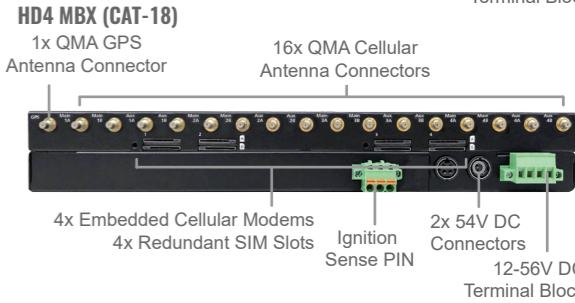
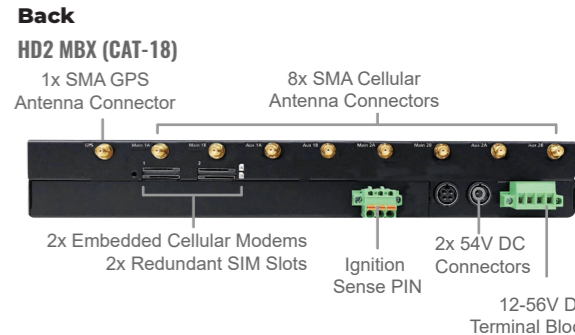
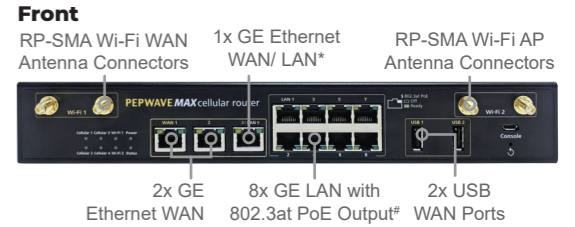

* WAN 3 is configured as a LAN port by default, configuration is changeable on the Web Admin.
2x 54V DC input is needed for all 8x LAN ports to have 802.3at PoE. Plugging in 1x 54V DC input will result in 4x LAN ports having 802.3at PoE.
^ With purchase of optional SpeedFusion License (MAX-HD-020-SPF/SFN-LC-50) can connect to up to 20/50 SpeedFusion peers respectively.

Ordering Information

Product Code	Description	Carrier/Category	Embedded Modems	4G Bands	3G Bands
MAX-HD4-MBX-LTEA-R-T	Includes 1x 54V Power Supply and PoE License. Enables 4x 802.3at PoE Output Ports	America / FirstNet / CAT-12	4	B1, B2, B3, B4, B5, B7, B8, B9, B12, B13, B14, B18, B19, B20, B26, B29, B30, B32, B41, B42, B43, B46, B48, B66	B1, B2, B4, B5, B6, B8, B9, B19
MAX-HD4-MBX-LTEA-K-T	Includes 1x 54V Power Supply and PoE License. Enables 4x 802.3at PoE Output Ports	Global* / CAT-12	4	B1, B2, B3, B4, B5, B7, B8, B9, B12, B13, B18, B19, B20, B26, B28, B29, B30, B32, B41, B42, B43, B46, B48, B66	B1, B2, B4, B5, B6, B8, B9, B19

* China & HK TD LTE are excluded.

Custom Options

Product Code	Description
ACW-630	Includes 1x 54V, 3.34A Power Supply Enable 4x LAN with 802.3at PoE output (PoE License automatically applied after kit purchase)
ACW-633	Includes 2x 54V, 3.34A Power Supply Enables 8x LAN with 802.3at PoE output (PoE License automatically applied after kit purchase)
MAX-HD-020-SPF	Supports up to 20 PepVPN/SpeedFusion Peers
SIM-BK8-4E-56V	SIM Injector, 8x SIM cards capacity, 4x 10/100/1000 LAN ports, 56V DC
SFN-LC-50	Up to 50 SpeedFusion Bonding License Key for MAX HD4 MBX
ANT-MB-40G-S-W-6	5-in-1 Cellular Antenna System with GPS Receiver (White)
ANT-MB-40G-S-B-6	5-in-1 Cellular Antenna System with GPS Receiver (Black)
ANT-MB-42G-S-W-6	7-in-1 Cellular and Wi-Fi Antenna System with GPS Receiver (White)
ANT-MB-42G-S-B-6	7-in-1 Cellular and Wi-Fi Antenna System with GPS Receiver (Black)
ANT-MB-02-R-W-6	2x2 MIMO Wi-Fi Dual Band Antenna (White)
ANT-MB-02-R-B-6	2x2 MIMO Wi-Fi Dual Band Antenna (Black)

Branch Office Network Resilience



2 8x 802.3at PoE to Power De-

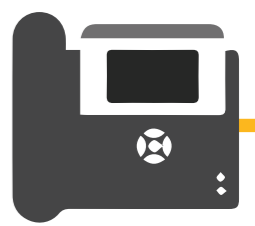

With SpeedFusion Bandwidth Bonding, the HD4 MBX is capable of combining the bandwidth of 4x Gigabit LTE connections into a fast and reliable SD-WAN connection. This means that even if your wired connections go down, the HD4 MBX will still keep your office connected. When you need to upgrade to 5G, simply swap the cellular module and the router is ready, it's that easy.

The HD4 MBX supports up to 8x 802.3at PoE connections, enabling you to connect your IP phones, IP cameras, and access points with minimal cabling. It also delivers 802.11ac dual-band dual-radio Wi-Fi with a customizable captive portal for guest access. The HD4 MBX comes equipped with SpeedFusion WAN Smoothing, mitigating packet loss and ensuring that your videoconferences are jitter-free. For multi-branch deployments, all our devices support InControl cloud management for easy SD-WAN provisioning, and group-based updates and configuration.



3 Delivers 802.11ac Wi-Fi

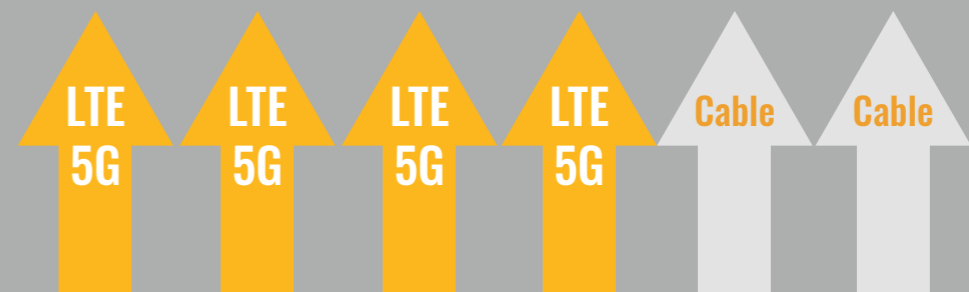
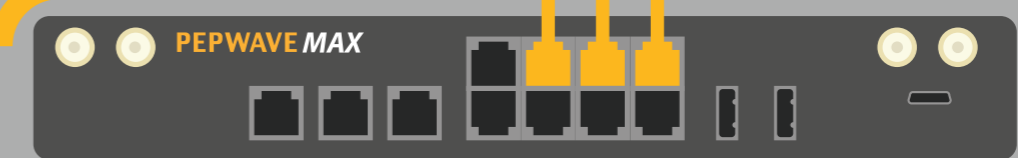

1 Add the reliability of 4x cellular links to your VPN. Upgrade to 5G when needed.

Wi-Fi Connectivity for Employee Shuttles

SpeedFusion SD-WAN combines the bandwidth of 4x Gigabit LTE connections on a packet level, ensuring employee productivity remains uninterrupted when cellular connections break. The MBX has swappable cellular modules, so when 5G technology comes, simply insert the 5G module and you are set.

The HD4 MBX can deliver 8x 802.3at PoE outputs, it also supports 802.11ac dual-band dual-radio Wi-Fi with a customizable captive portal. The HD4 MBX supports ignition sensing: the ability to turn on and off based on the ignition status of the vehicle.

Our ecosystem has other services to meet the challenges of employee bus deployments. Use the SD-PMU to regulate voltage and manage power delivery from the cloud. Using our Smart Readers and TA app, you can control bus access and track employee usage. Using InControl, you can remotely configure your devices and monitor your entire fleet on a real-time map as needed.

Rolling Stock Certification

EN 61373:1999
IEC 61373:1999
EN 50155
EN 61000

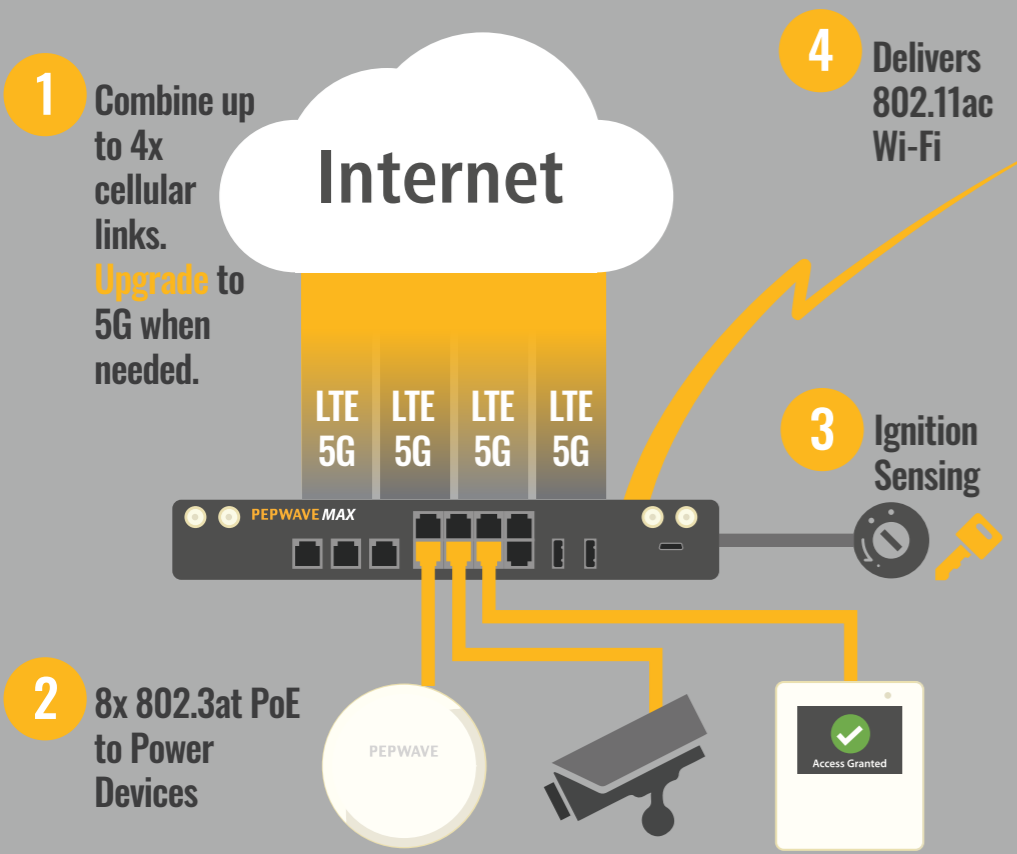

In-Vehicle Power Management: SD Power Management Unit

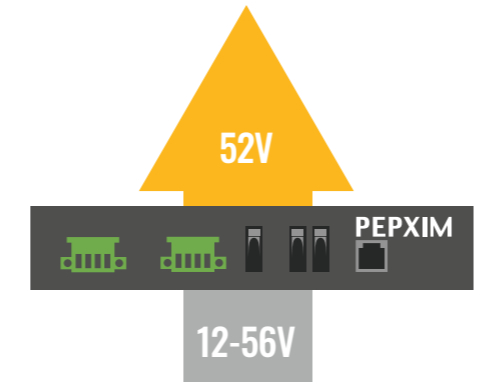

Voltage regulation and boost, monitor battery health on the cloud, low power disconnect.

Employee and Capacity Tracking: Time and Attendance System



Track bus access using RFID cards. Review usage records on the TA cloud platform.

Remote Config & Fleet Tracking: InControl Cloud Management



Track your entire fleet on a single map. Standardize router and Wi-Fi configuration.

Public Safety - Mobile Command

Live Stream Without Infrastructure:

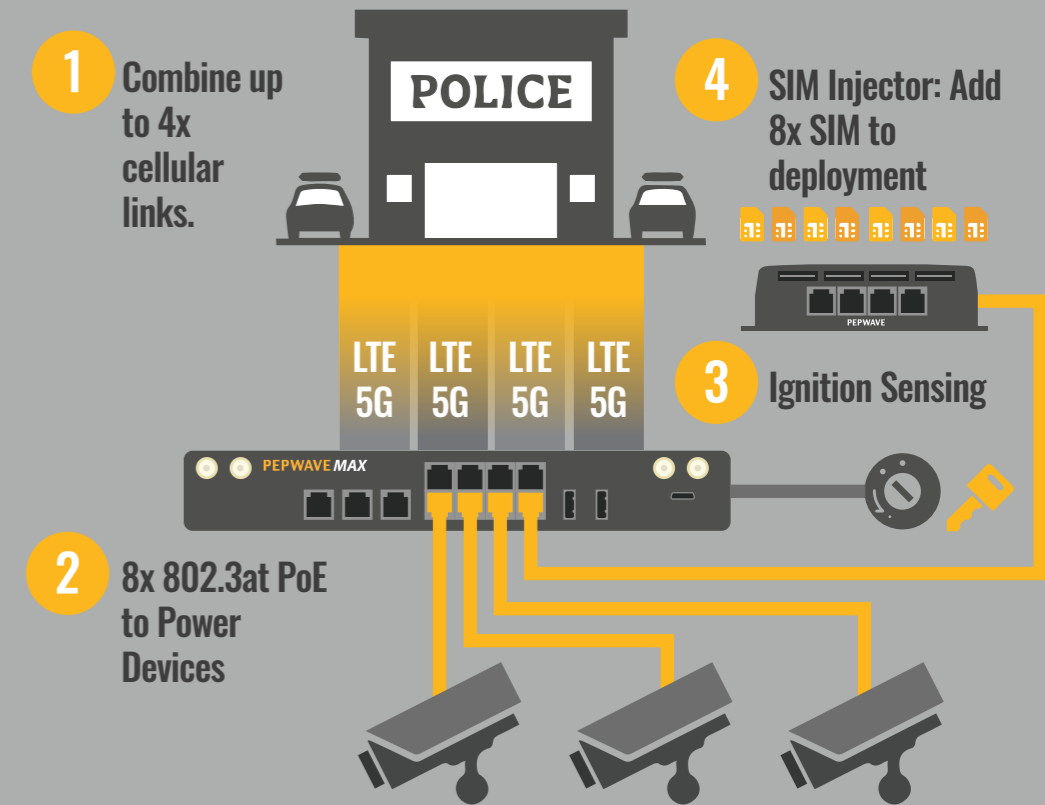

The HD4 MBX combines the bandwidth of 4x Gigabit LTE links into a fast, reliable, and secure SD-WAN connection, enabling you to stream high-definition video in real-time. This can all be achieved without investing in any infrastructure. With SpeedFusion-enabled devices on multiple vehicles and aerial resources, you can monitor the situation from multiple perspectives without needing a line-of-sight connection.

The HD4 MBX supports 8x 802.3at PoE so that you can power and connect your cameras and IP phones with minimal cabling. It also delivers 802.11ac Wi-Fi for securely connecting your mobile devices to headquarters. The HD4 MBX supports ignition sensing, which enables the device to turn on and off based on the ignition status of the vehicle, protecting your batteries.

For additional network resilience, the optional SIM injector can add up to 8 SIM cards to your deployment. You can separate the router and the SIM injector by up to 150m, making switching SIM cards a breeze.

Instant Connectivity for Temporary Sites



2 8x 802.3at PoE to Power De-

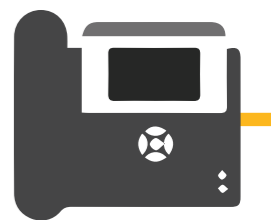

The HD4 MBX provides you with instantly deployable connectivity, available right when the first boots hit the ground. By combining the bandwidth of up to 4x Gigabit LTE connections, you can perform fast and reliable connectivity no matter where the site is located. Quickly and safely transmit project data, emails, plans, and blueprints between personnel, sites, and headquarters. The HD4 MBX also has an upgradable cellular module, so 5G connectivity is as simple as switching the module. Together, these features can save months of lead time.

The HD4 MBX supports 8x 802.3at PoE ports to power your IP phones, cameras, and access points, simplifying your cabling. It can also deliver secure 802.11ac Wi-Fi with a customizable captive portal for staff and guests to connect to. For additional network reliability, the optional SIM injector adds another 8x SIM cards to your deployment.

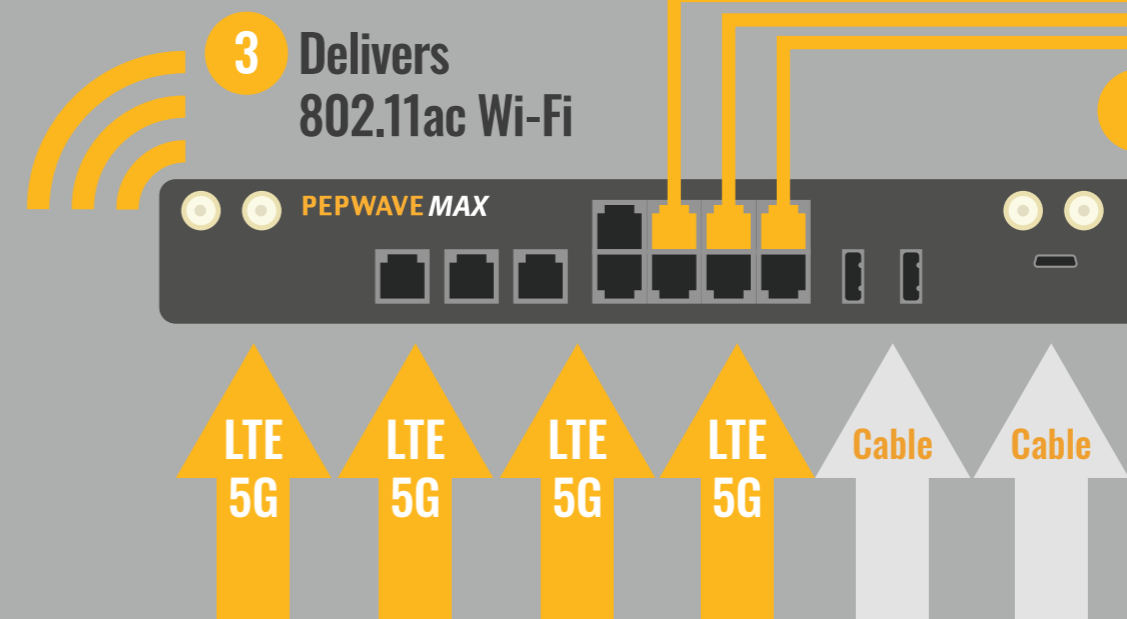

Event Live Streaming and Connectivity



2 WAN Smoothing technology ensures jitter-free video streaming.

Keep your event connected and your cameras streaming. With support for 4x Gigabit LTE connections, the HD4 MBX can keep your event connected no matter where it is held. It also has a modular cellular modem, so it's ready to upgrade to 5G anytime you are. The HD4 MBX has 8x 802.3at PoE ports, so you can simplify your cabling when connecting and powering your devices. It can deliver 802.11ac Wi-Fi which supports a customizable captive portal with advertisements. The captive portal and advertisements work with any connected access points as well.

By adding a video encoder to your deployment, you could also connect cameras for your event, ensuring that it has good online coverage. The cellular SpeedFusion SD-WAN connection provides all the bandwidth you need to stream HD video. What's more, our patented WAN Smoothing technology compensates for packet loss, ensuring smooth, jitter-free streaming.

3 Delivers ad-supported 802.11ac Wi-Fi with a customized captive portal.

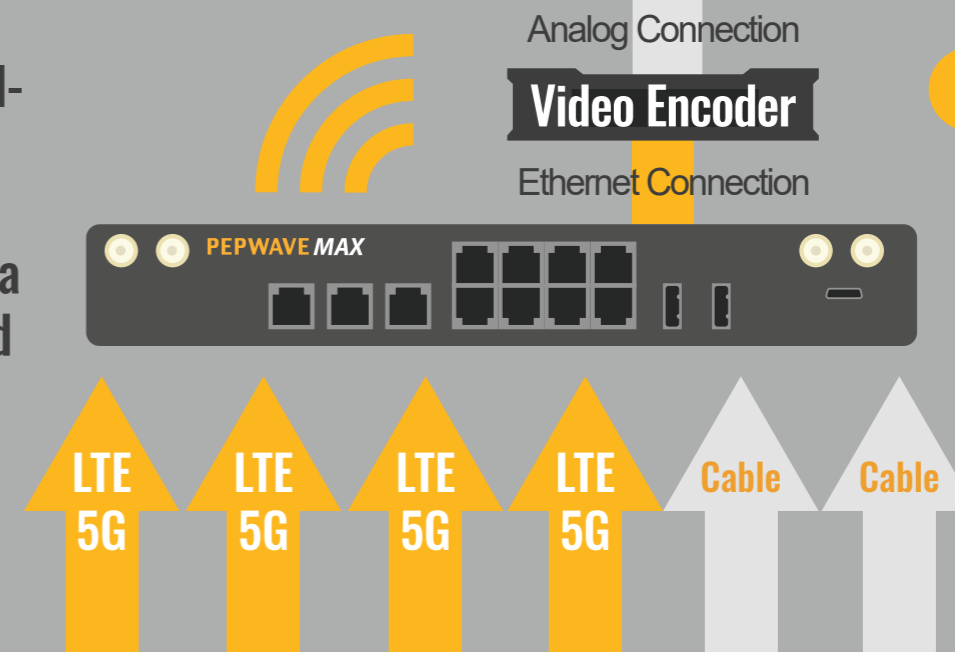

1 Combine bandwidth of 4x cellular links. Upgrade to 5G when needed.

Mobile Clinic - Telemedicine



4 SIM Injector

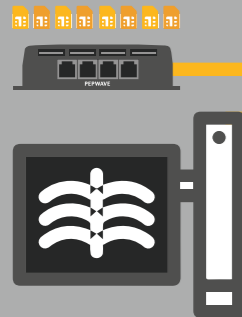

3 802.11ac Wi-Fi

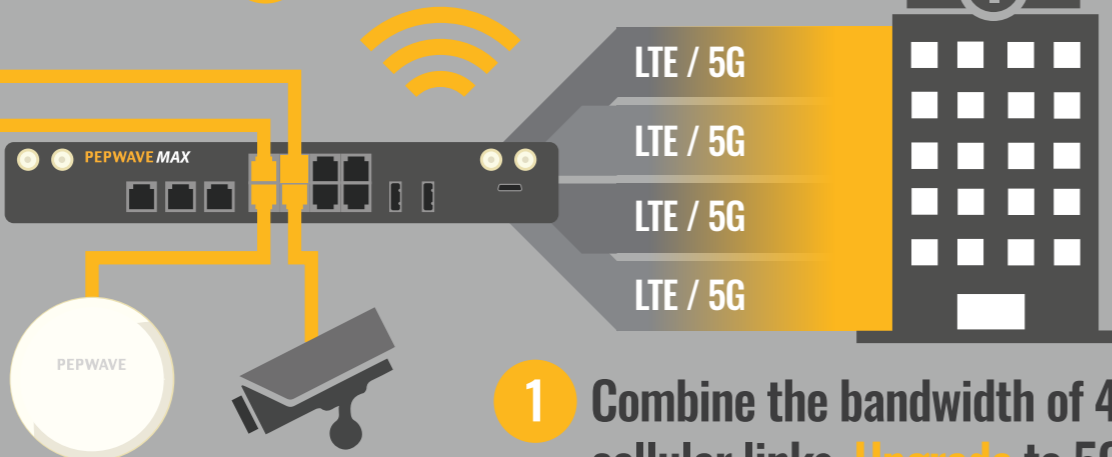

2 8x 802.3at PoE Output

1 Combine the bandwidth of 4x cellular links. Upgrade to 5G when needed.

Telemedicine has the potential to improve the lives of many patients, particularly those living in remote locations without access to specialist doctors. However, x-ray images and videostreams require large amounts of data, more data than a single cellular link can transfer in a timely manner. Our Solution: SpeedFusion SD-WAN. Using this technology, the HD4 MBX can combine the bandwidth of 4x Gigabit LTE connections to form a fast and reliable VPN connection that can handle the requirements of remote diagnosis. The MBX has a modular cellular modem, so it can upgrade to 5G whenever you are ready.

The HD4 MBX can support 8x 802.3at PoE Outputs to power your IP phones and access points. It can also deliver 802.11ac Wi-Fi to offer hotspots for staff and guests. For mobile medical facilities, the HD4 MBX has ignition sensing, which can turn the router on or off based on the ignition status of the vehicle. The HD4 also supports the optional SIM Injector, which can add another 8x SIM cards to the deployment, adding resiliency and carrier coverage to your mobile medical facility.