

Peplink Premium Deck mounts

Features

Rugged and heavy duty mounts are intended for deck and mast installations. The cable is protected inside the mount with direct feed through the deck or mast.

This mount is made from the highest quality Marine Grade Stainless Steel to withstand harsh weather conditions and prevent corrosion at sea.

Ordering information

Product Code	Description
ACW-650	Mobility thread to HD Dome
ACW-651	1" 14 TPI female to Mobility thread
ACW-652	1" 14 TPI male adapter

Application

- Deck Installations
- Mast Installations

Contact Us

sales@peplink.com

Find a Peplink Certified Partner

<https://www.peplink.com/peplink-certified-partners/>



Overview

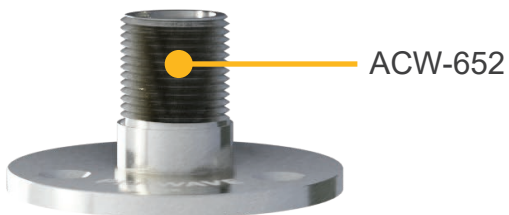
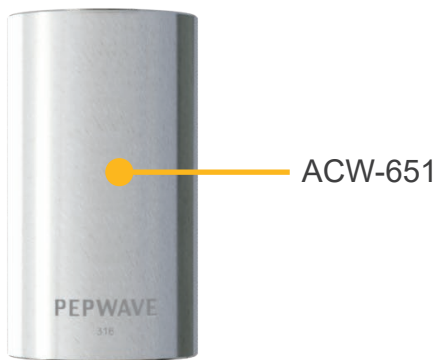
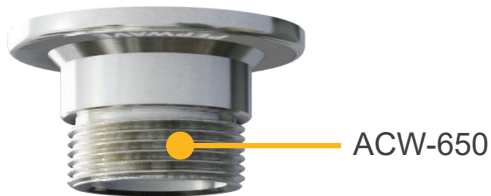

Compatible with MAX HD Dome series

Order Suggestion

With Maritime base	ACW-650+ ACW-651+ ACW-652
Without Maritime base	ACW-650+ ACW-651



Compatible with Mobility antenna series

Order Suggestion

With Maritime base	ACW-651+ ACW-652
Without Maritime base	ACW-651

Overview



Compatible with Maritime antenna series

Order Suggestion

ACW-652

* The Deck Mount Set is included in the Maritime 40G Antenna Package.

ACW-650

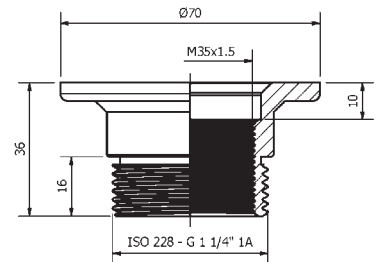
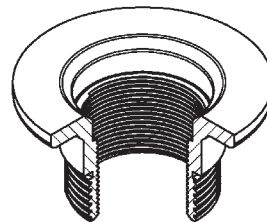

Mechanical Specification

Material	Stainless Steel SS316
Internal thread	M35x1.5 (compliant with HD Dome)
External thread	1" 14 TPI (fits to ACW-651)
Dimensions HxD	1.42" x 2.76" (36 x 70mm)
Weight	220g / 0.49 pounds

Ordering information

Product Code	Description
ACW-650	Mobility thread to HD2 Dome

ACW-651

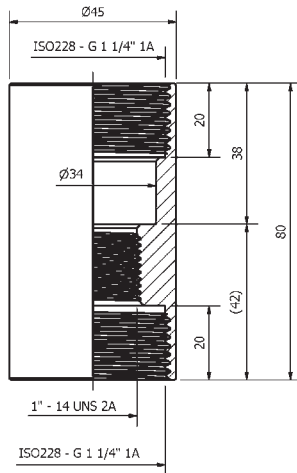
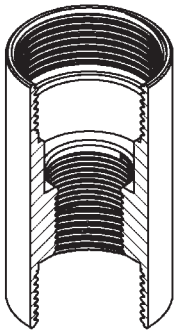

Mechanical Specification

Material	Stainless Steel SS316
Internal thread 1 (Top and Bottom)	1 1/4" 11 TPI
External thread 2 (Bottom)	1" 14 TPI
Dimensions HxD	3.15" x 1.77" (80 x 45mm)
Weight	385g / 0.85 pounds

Ordering information

Product Code	Description
ACW-651	1" 14 TPI female to Mobility thread

ACW-652

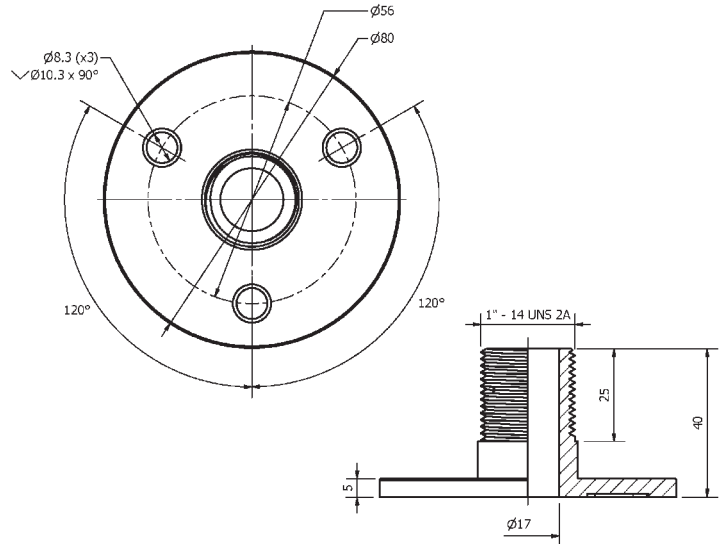

Mechanical Specification

Material	Stainless Steel SS316
External thread	1" 14 TPI
Dimensions HxD	1.57" x 3.15" (40 x 80mm)
Weight	250g / 0.55 pounds

Ordering information

Product Code	Description
ACW-652	1" 14 TPI male adapter